

# 2013 NSA Section 3 Coding Manual

**C** = Correct

**R** = Relational Error

**D** = Distractor Error

**O** = Other Error

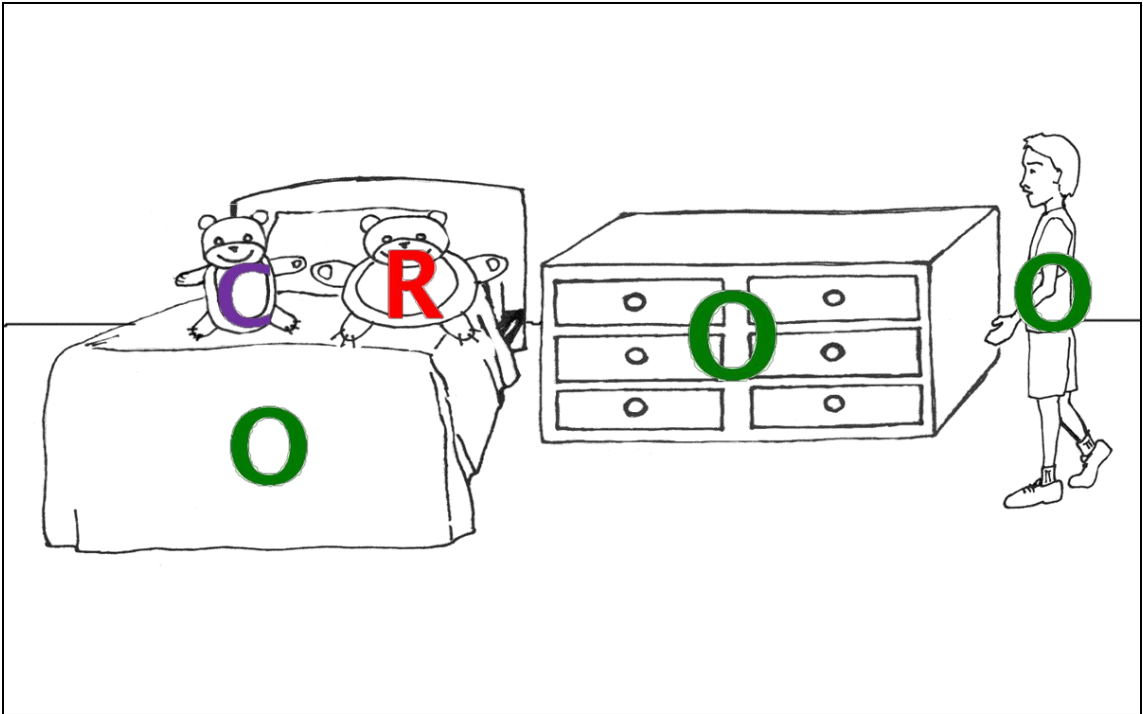
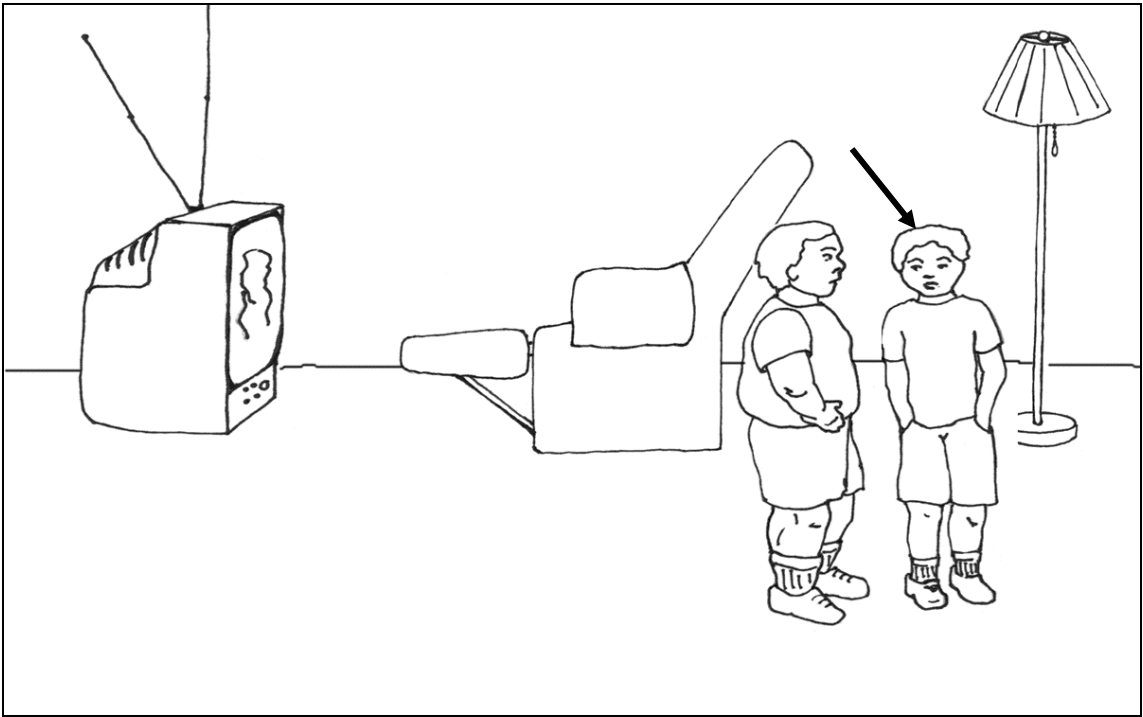

SAMPLE 01

Birthdate \_\_\_\_\_

Testing Date \_\_\_\_\_

Identification \_\_\_\_\_

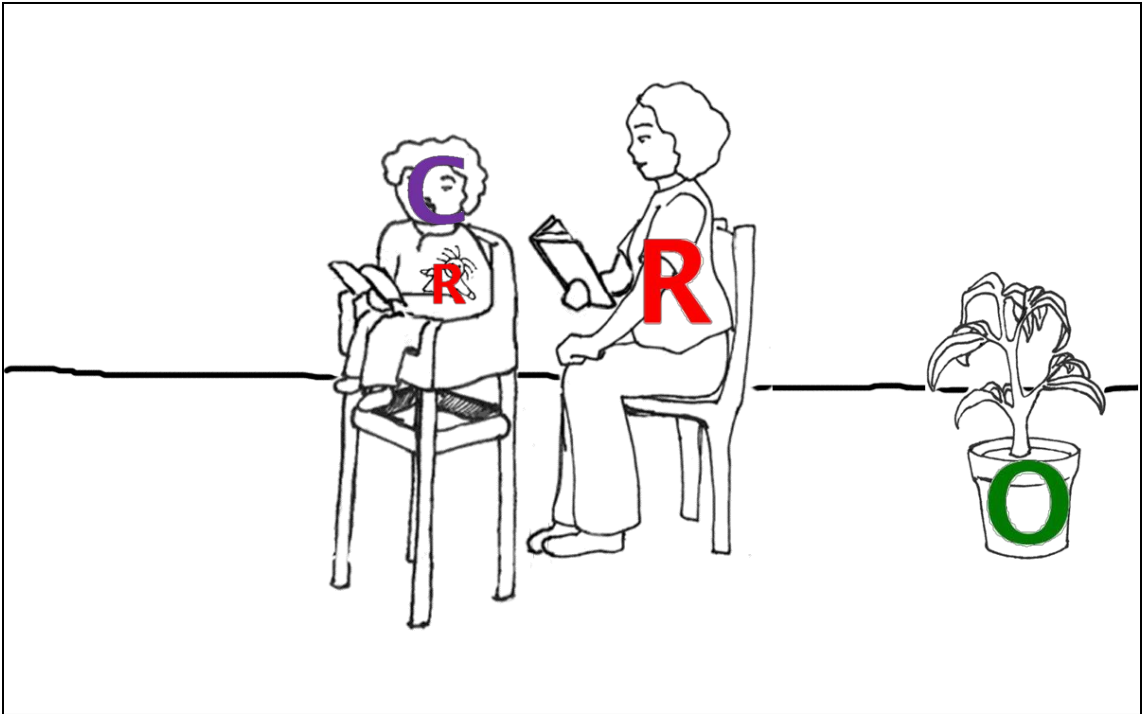

Sample 02

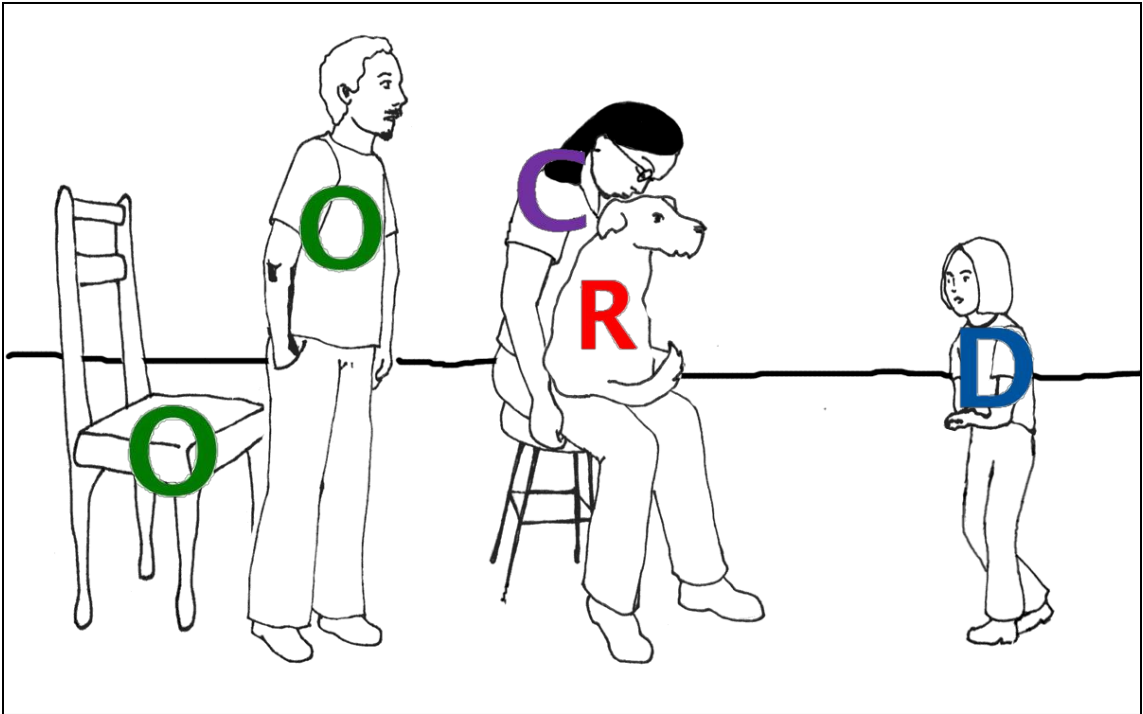
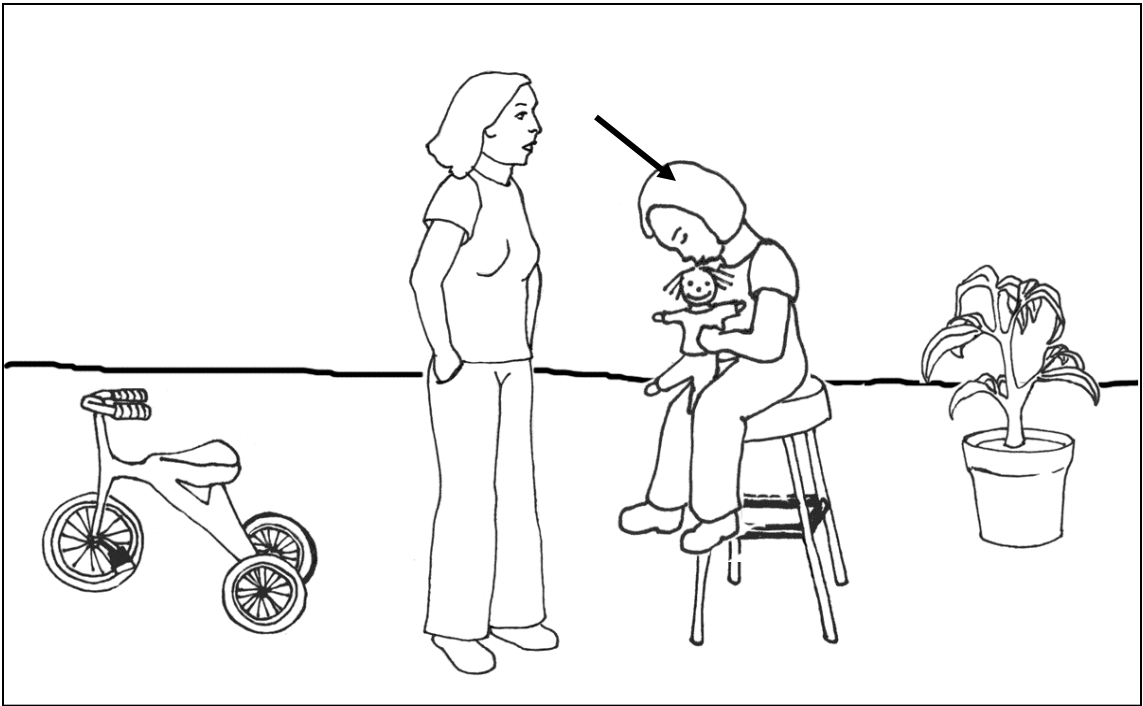

Problem 1-1a



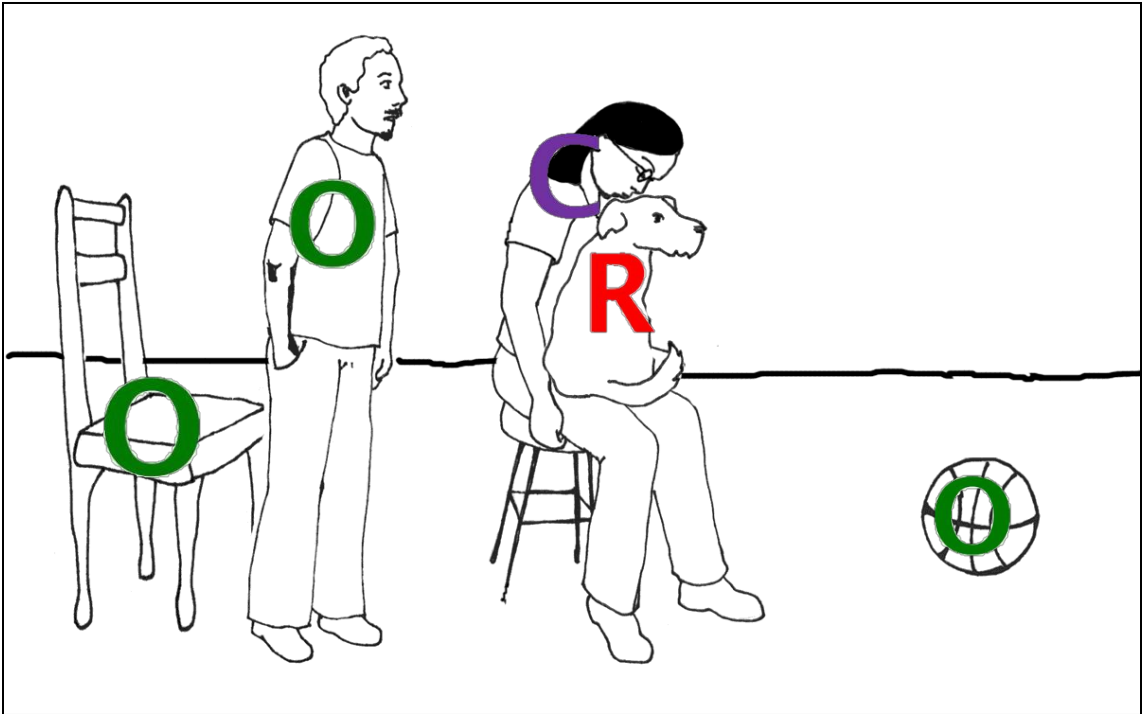
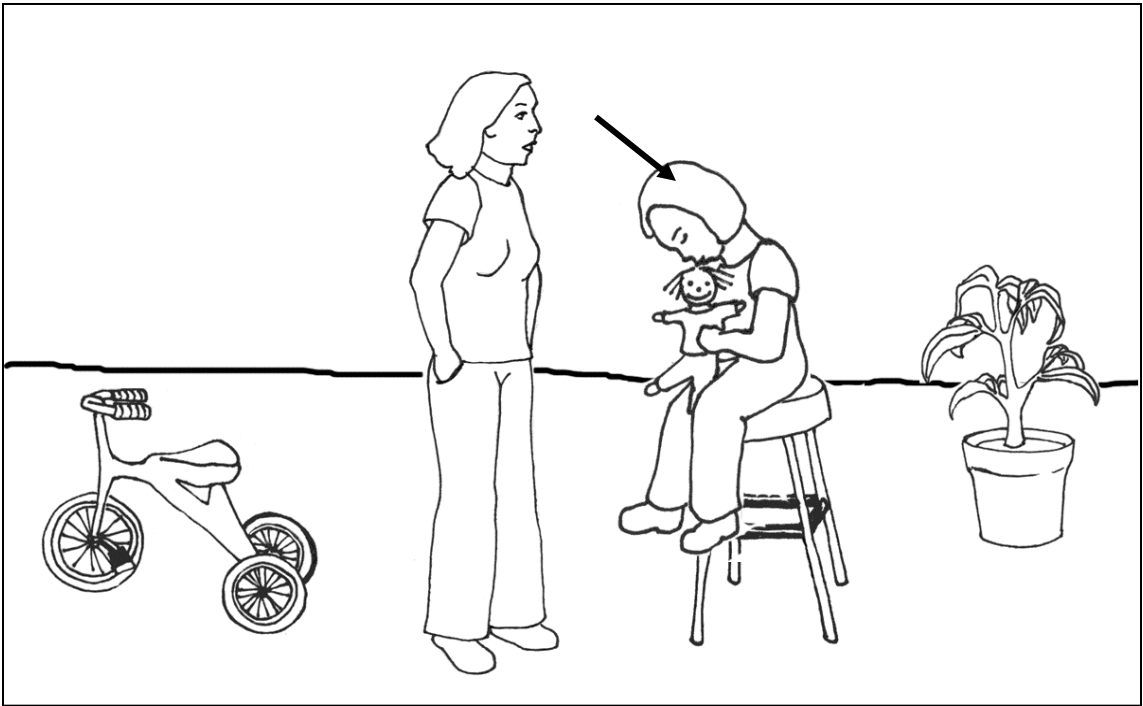

Problem 1-1b

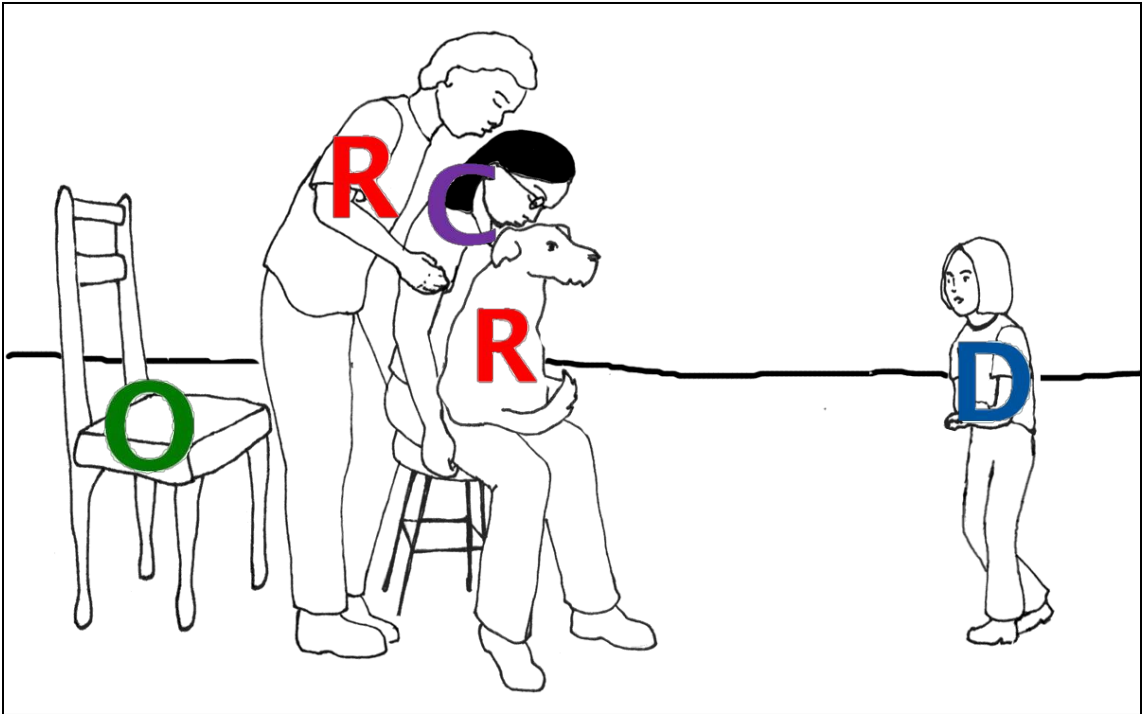
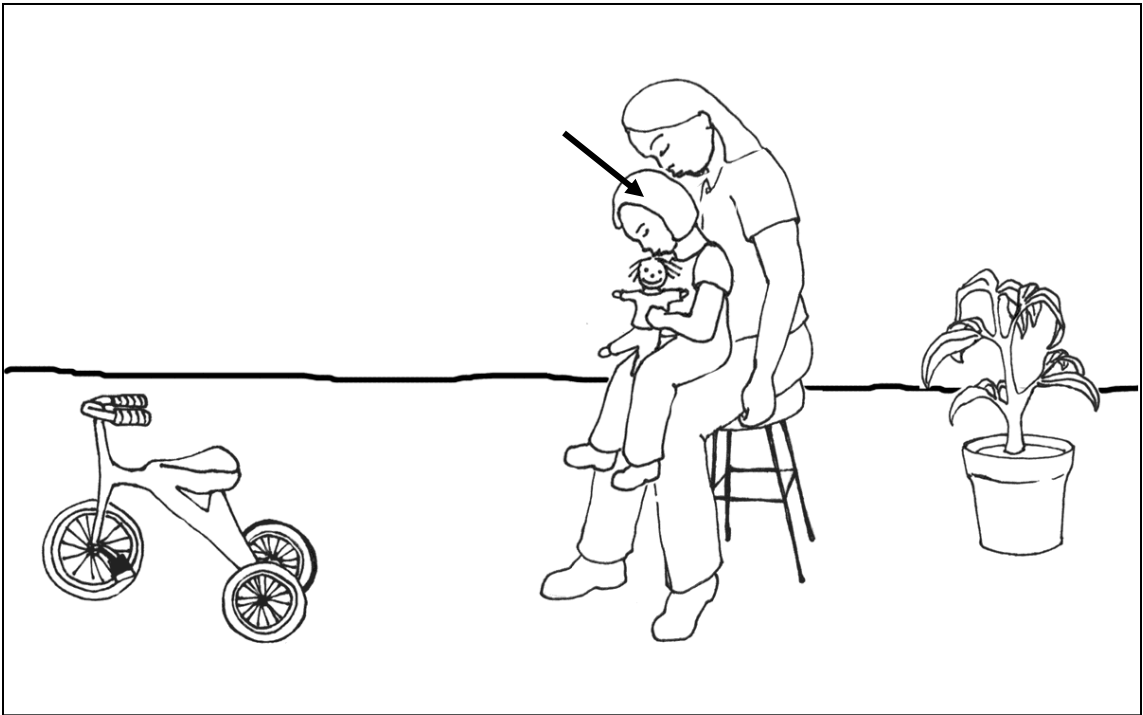

Problem 1-2a

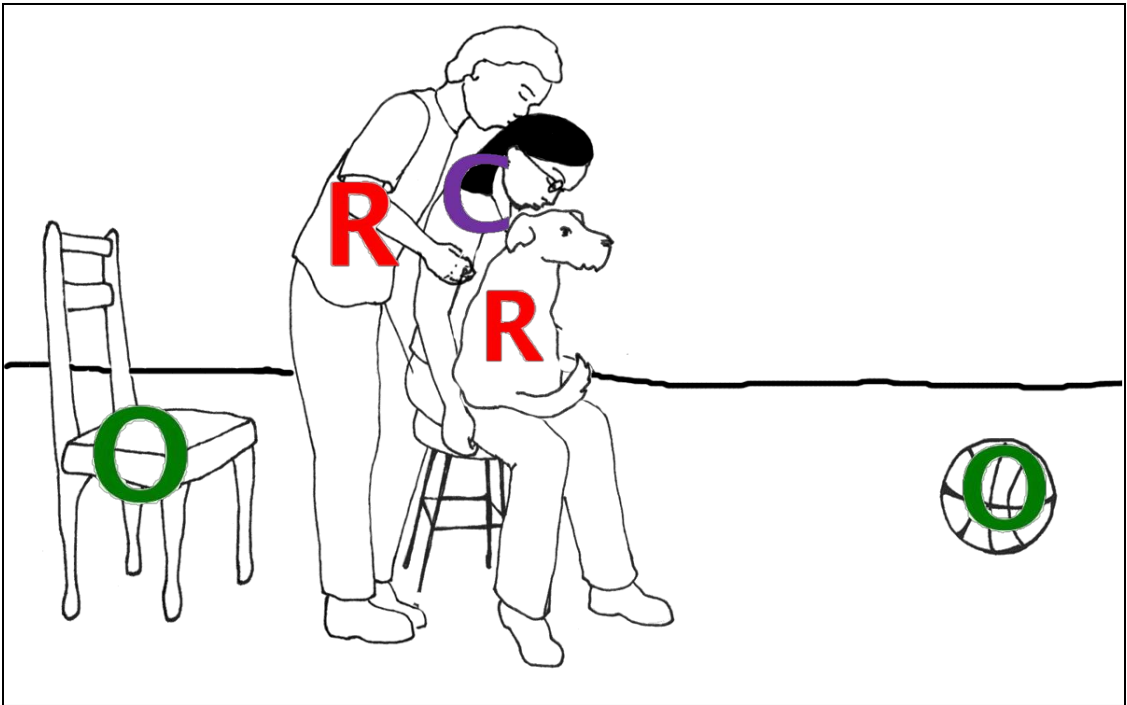
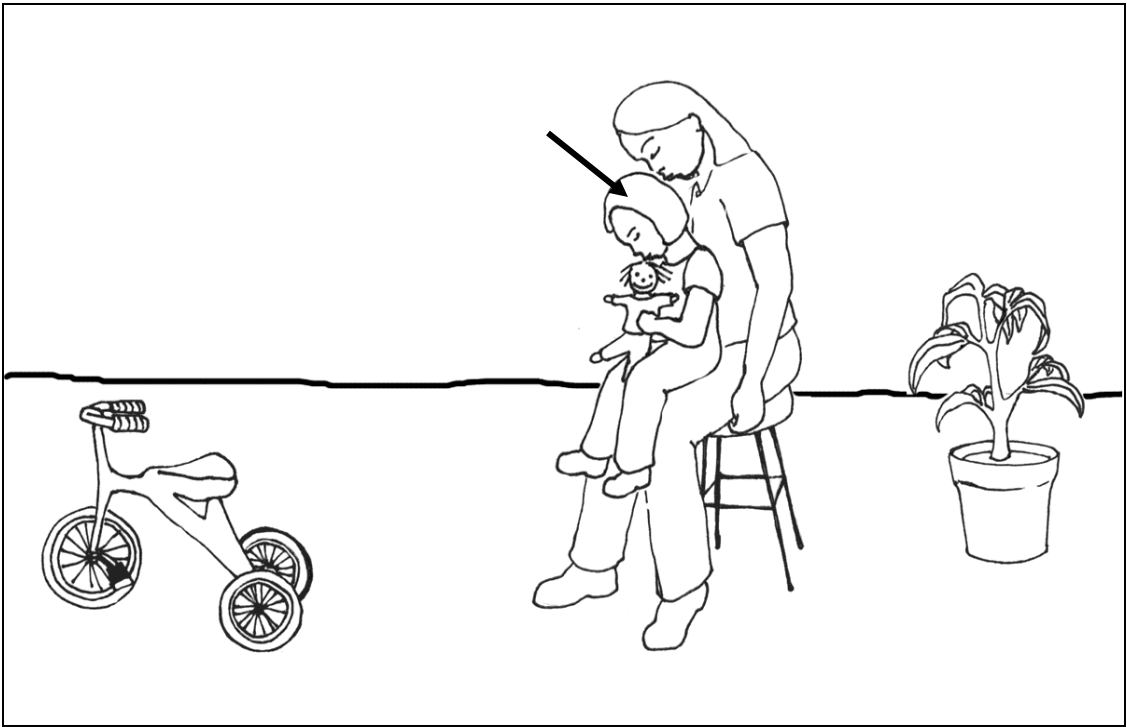

Problem 1-2b

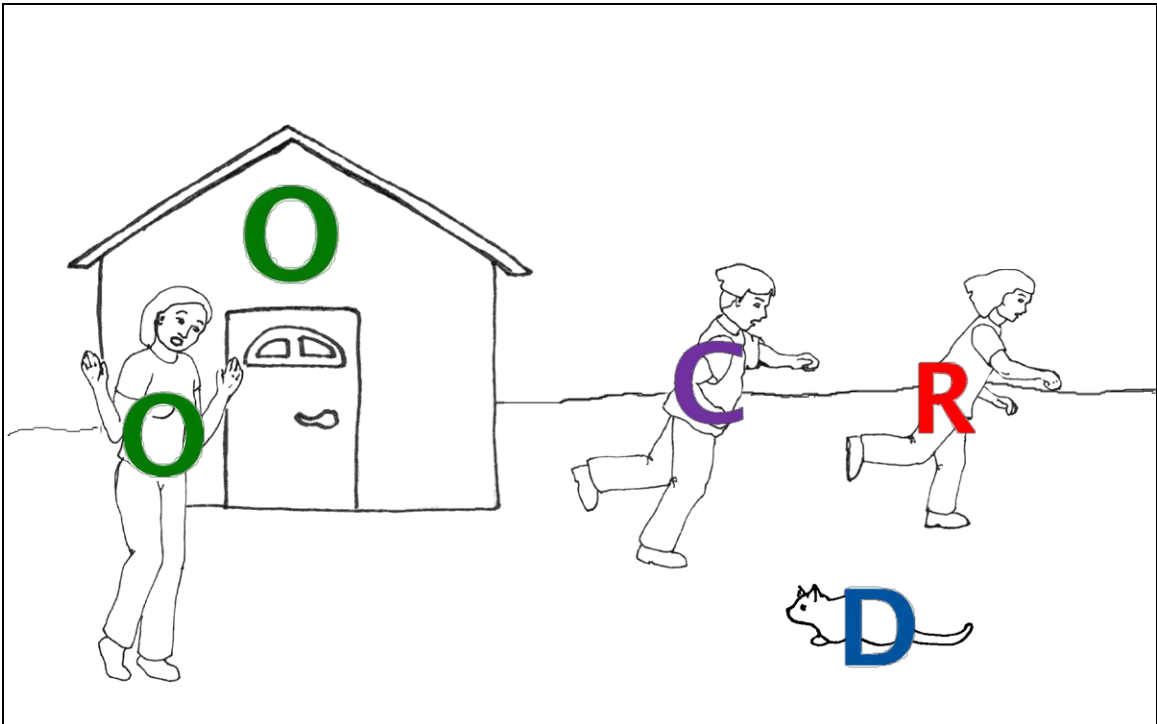
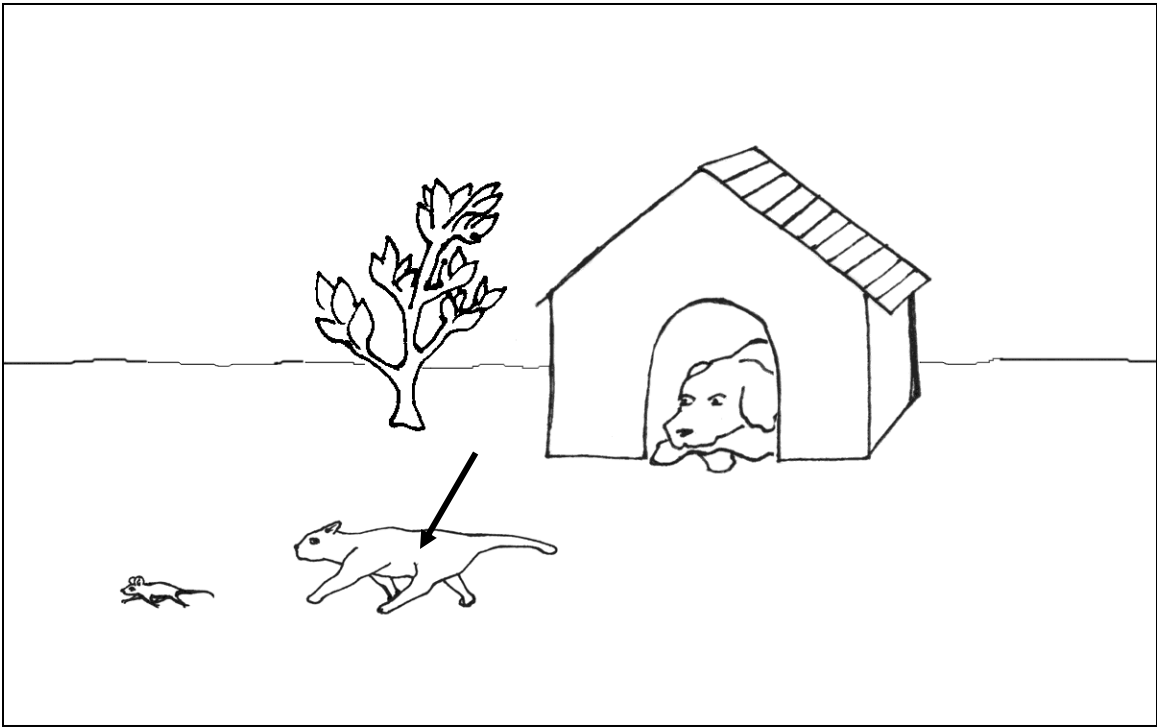

Problem 2-1a

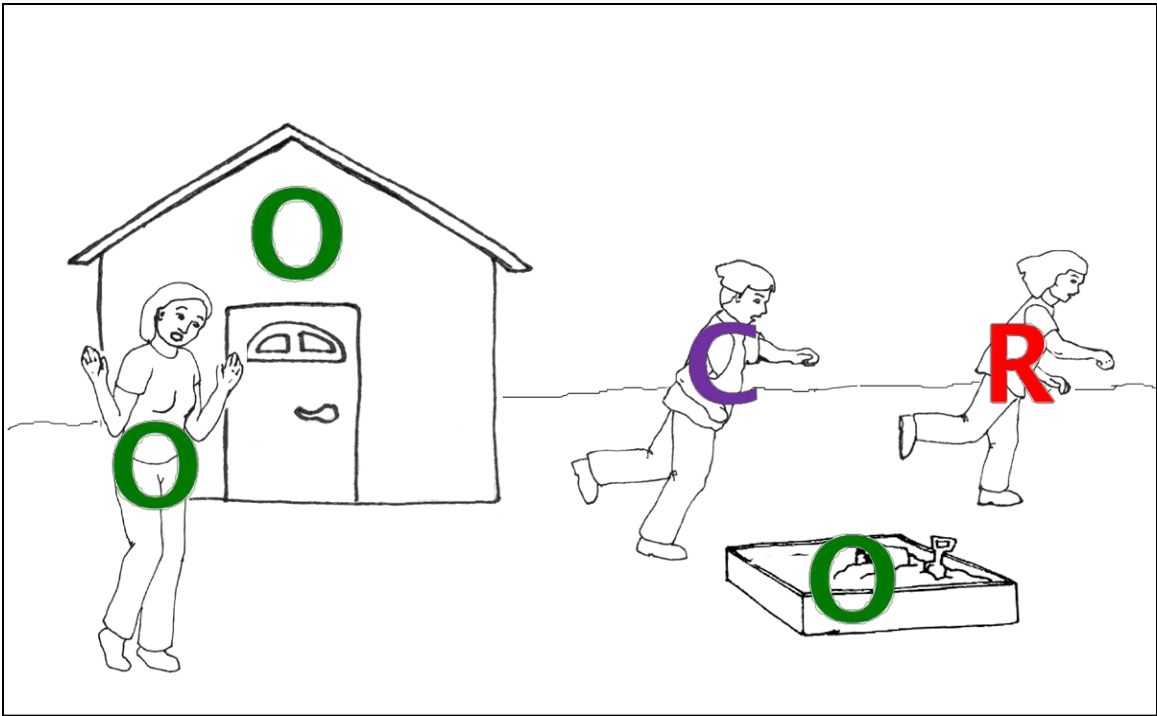
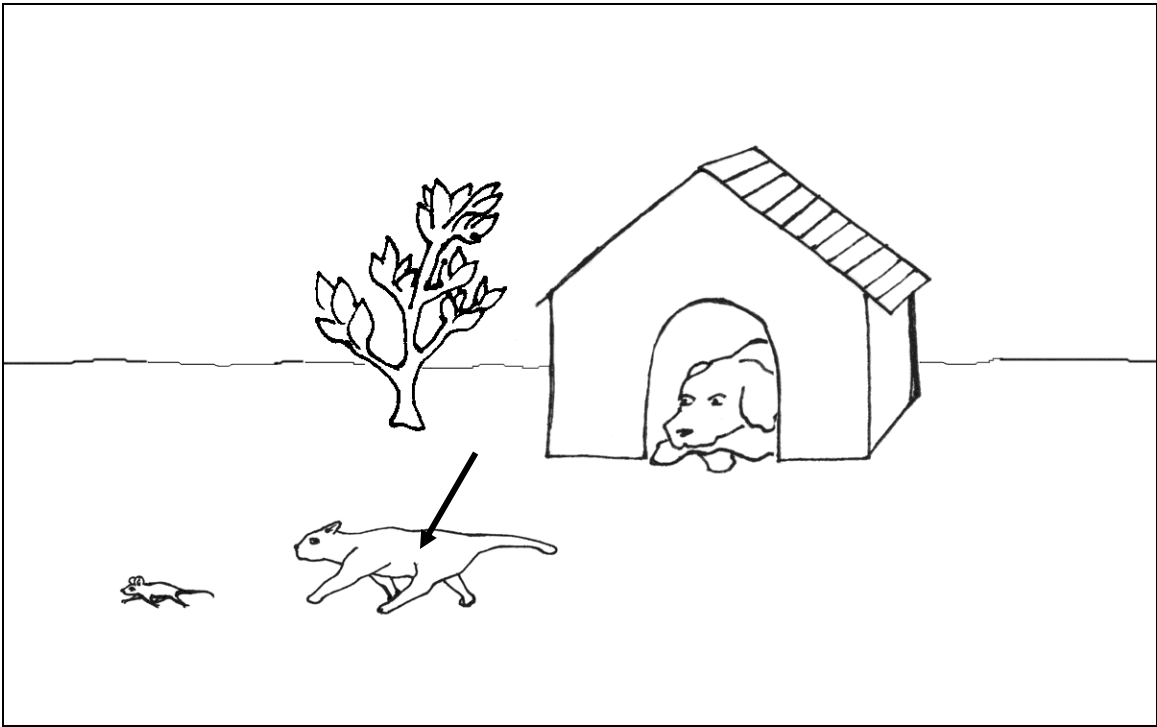

Problem 2-1b

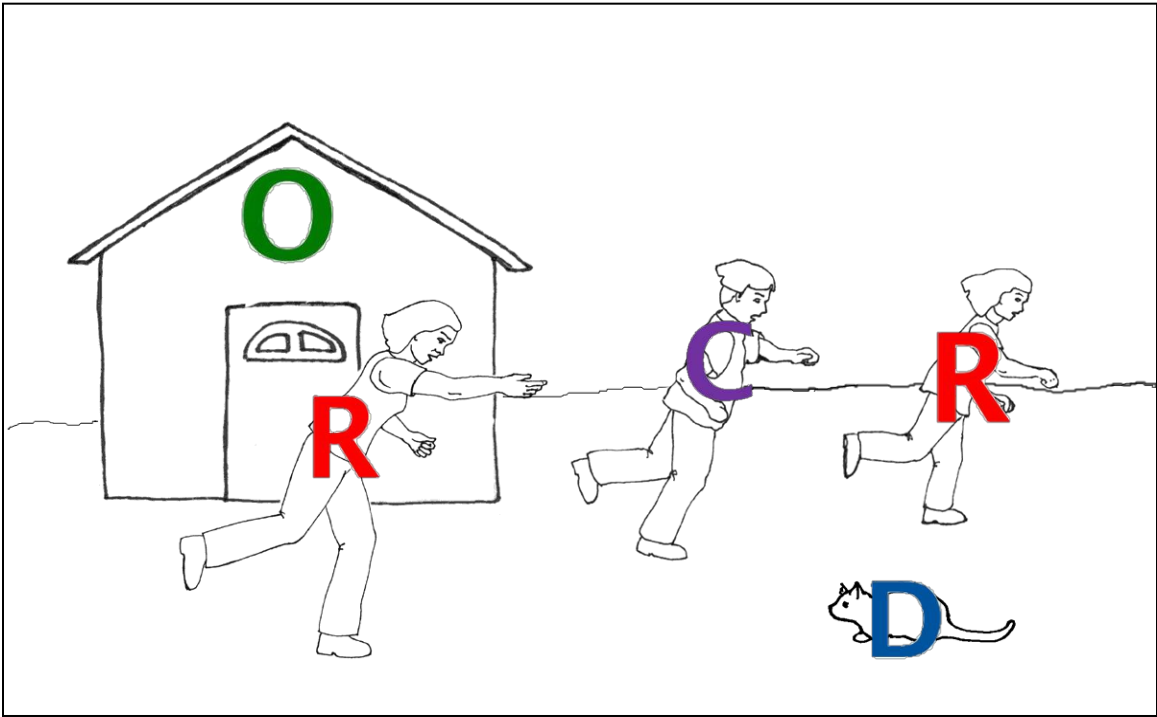
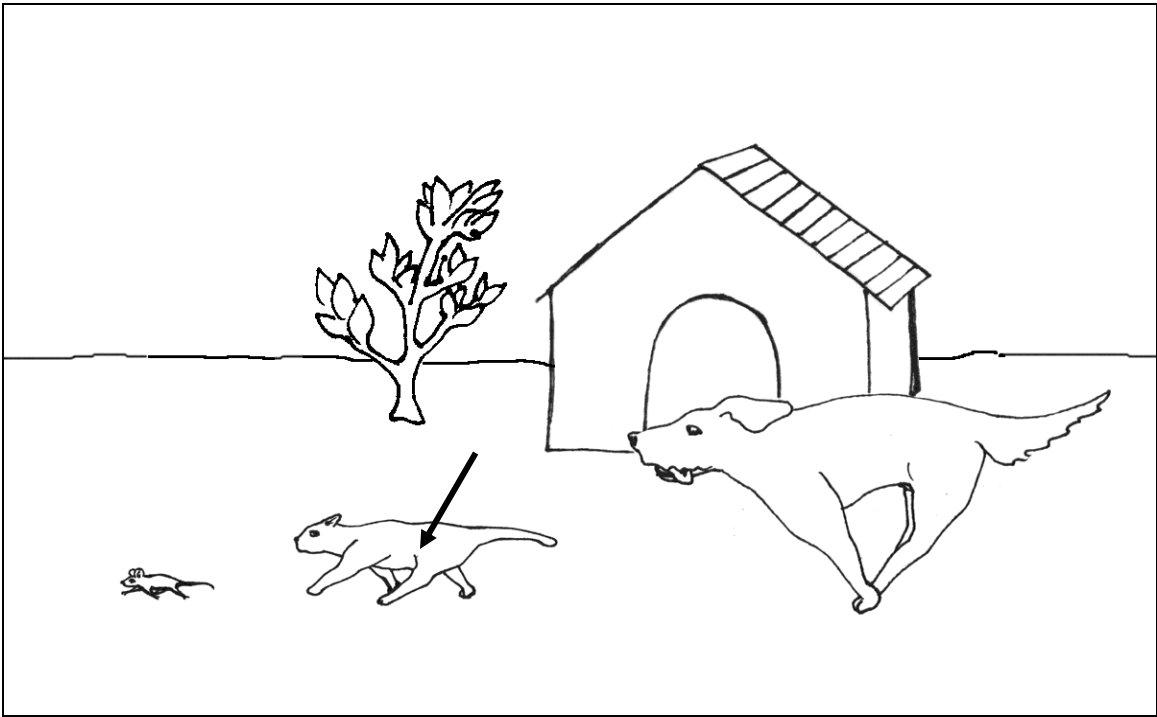

Problem 2-2a

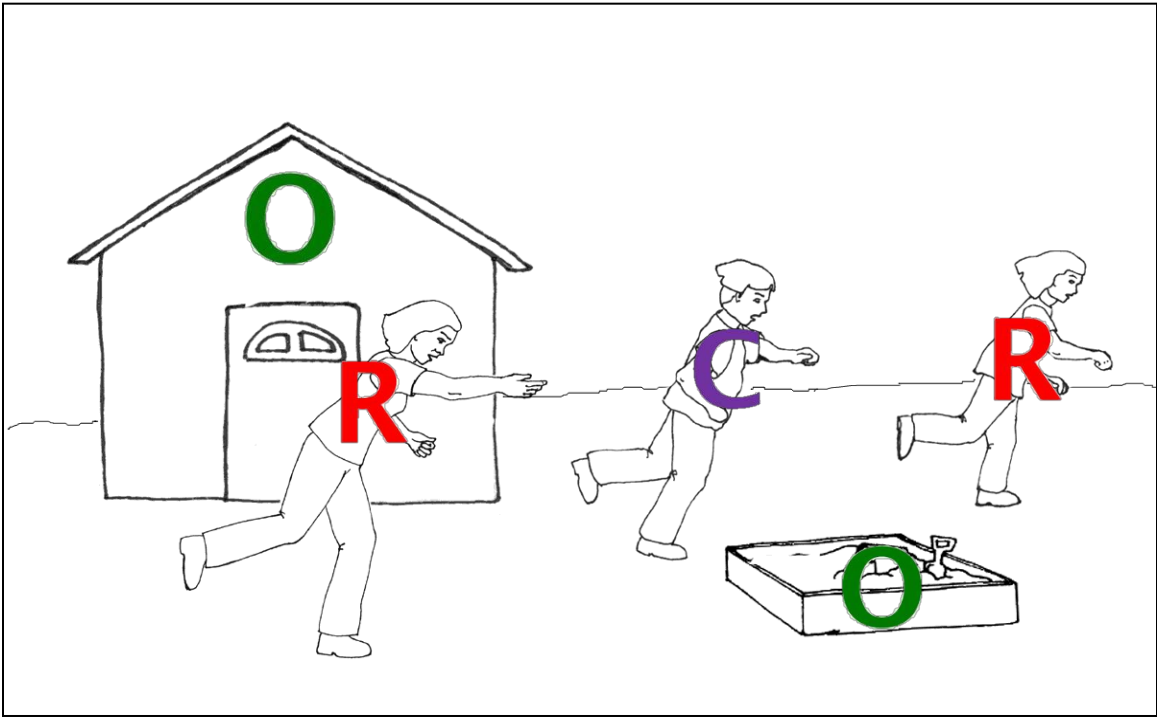
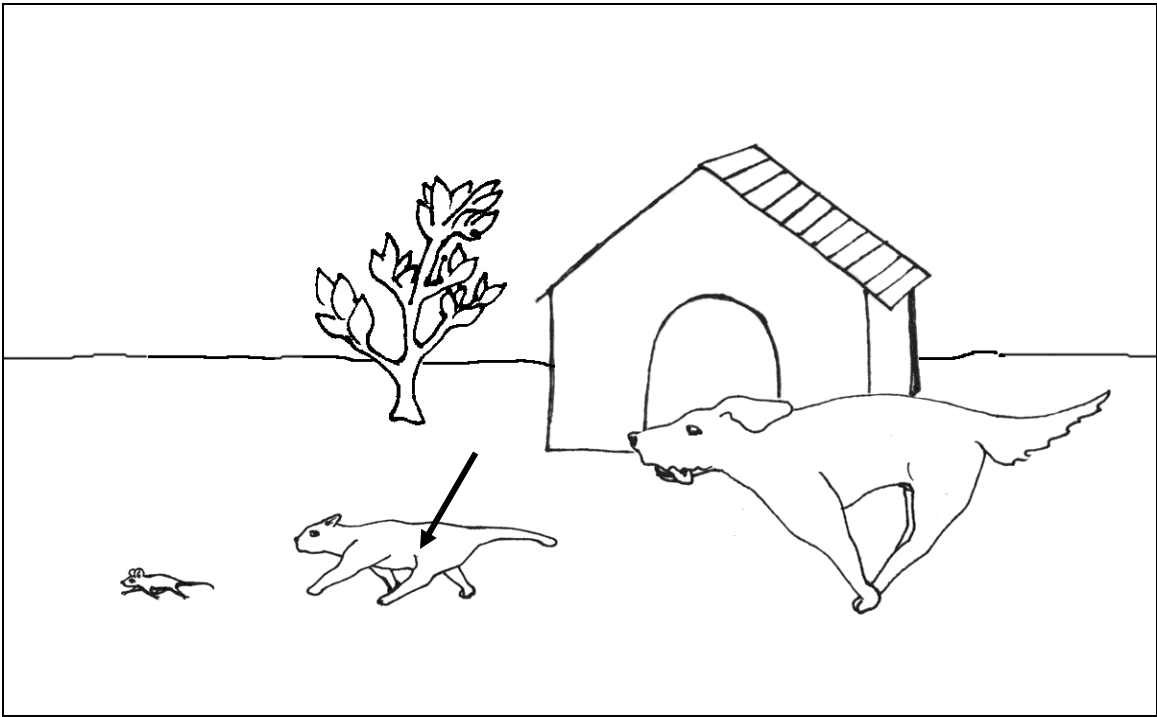

Problem 2-2b

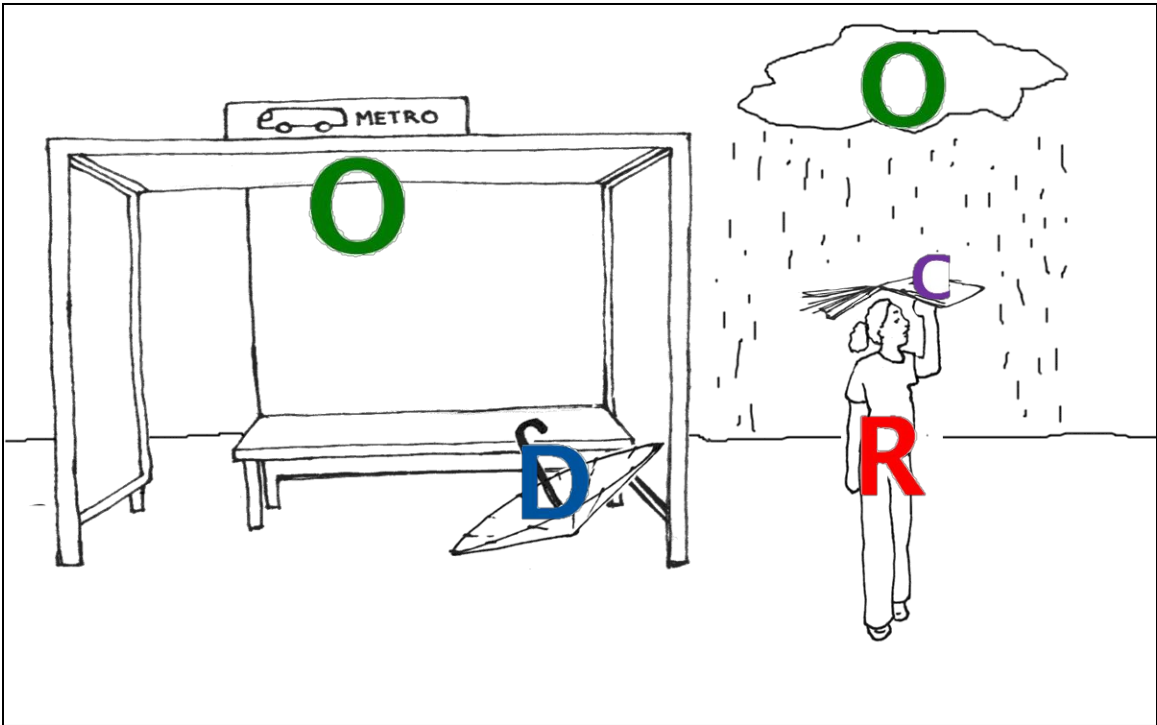
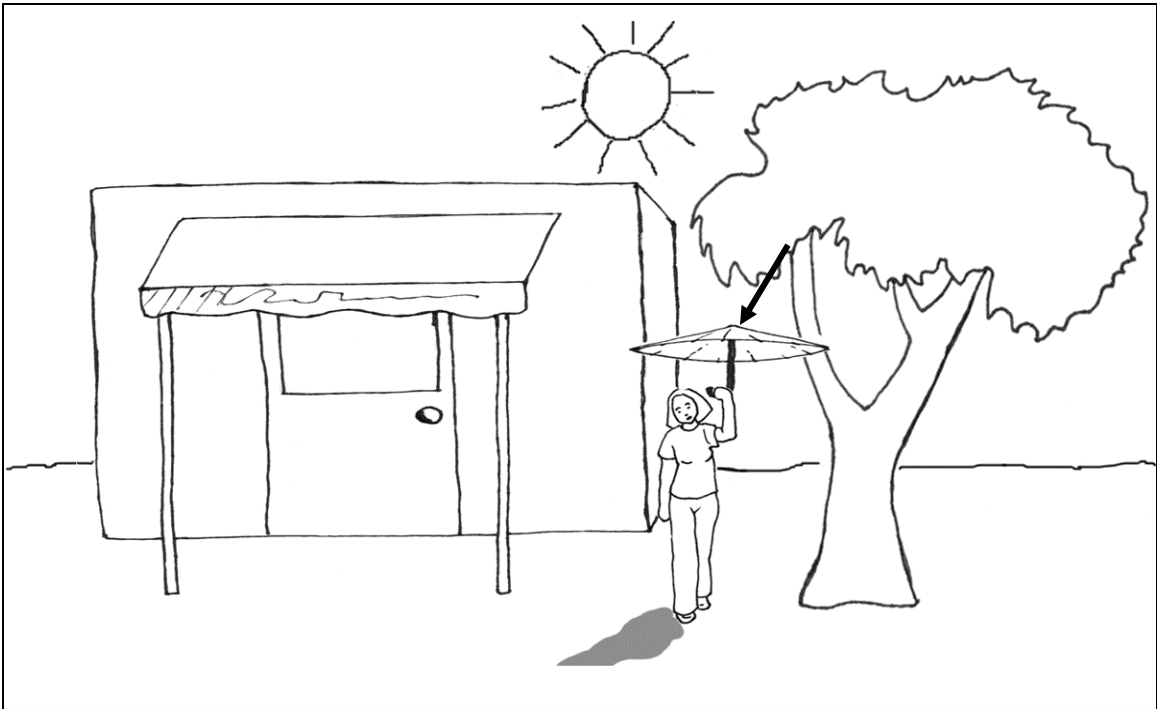

Problem 3-1a



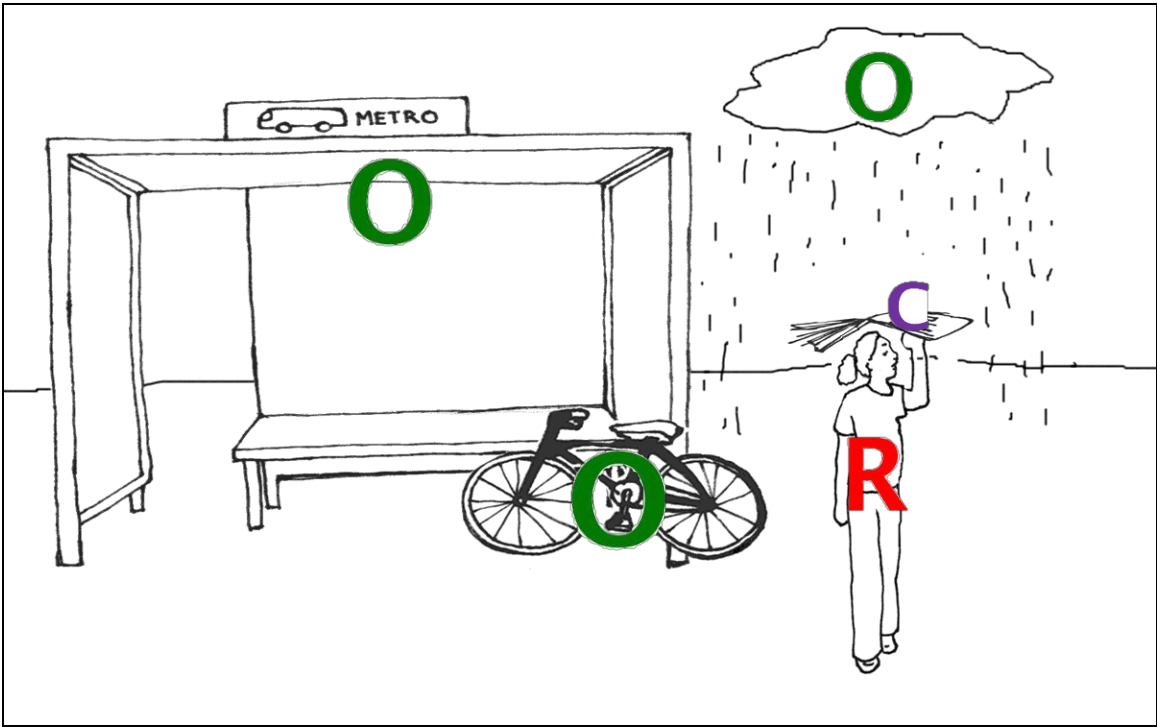
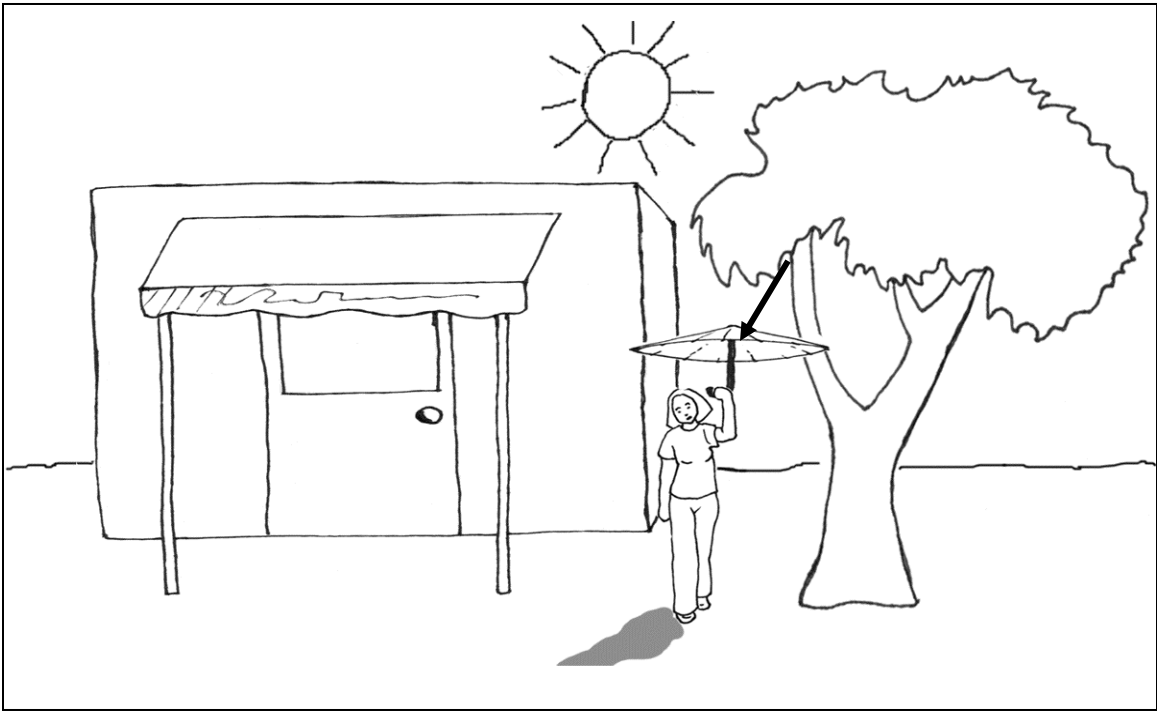

Problem 3-1b

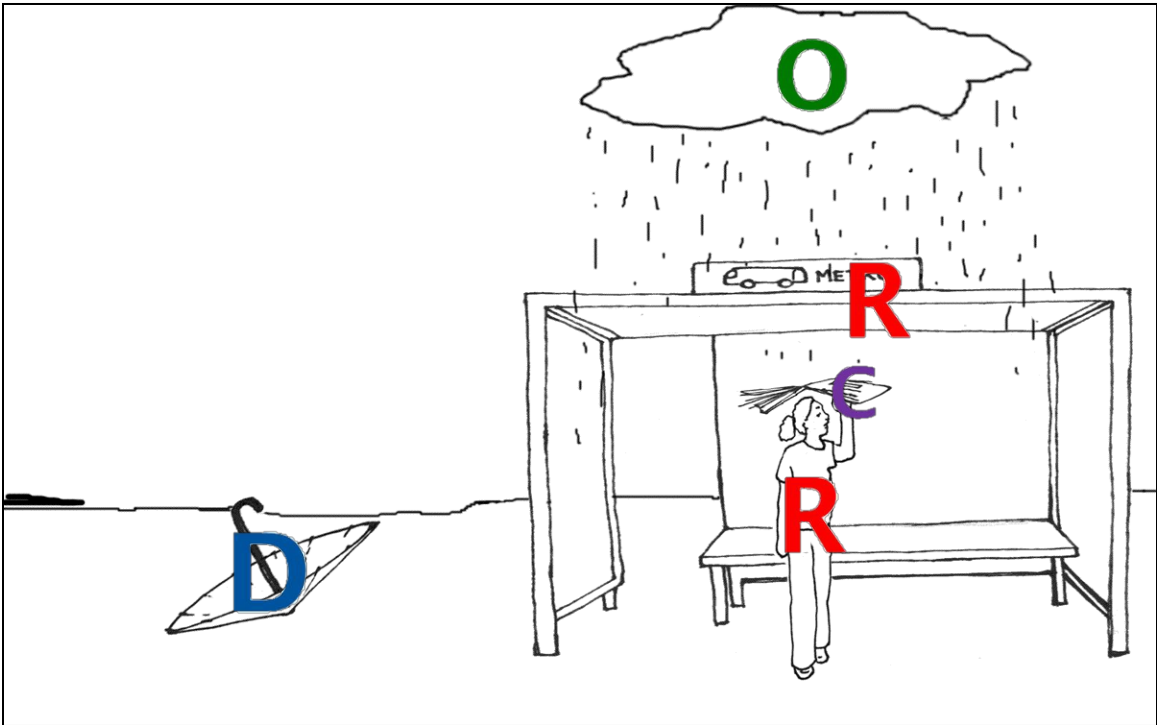
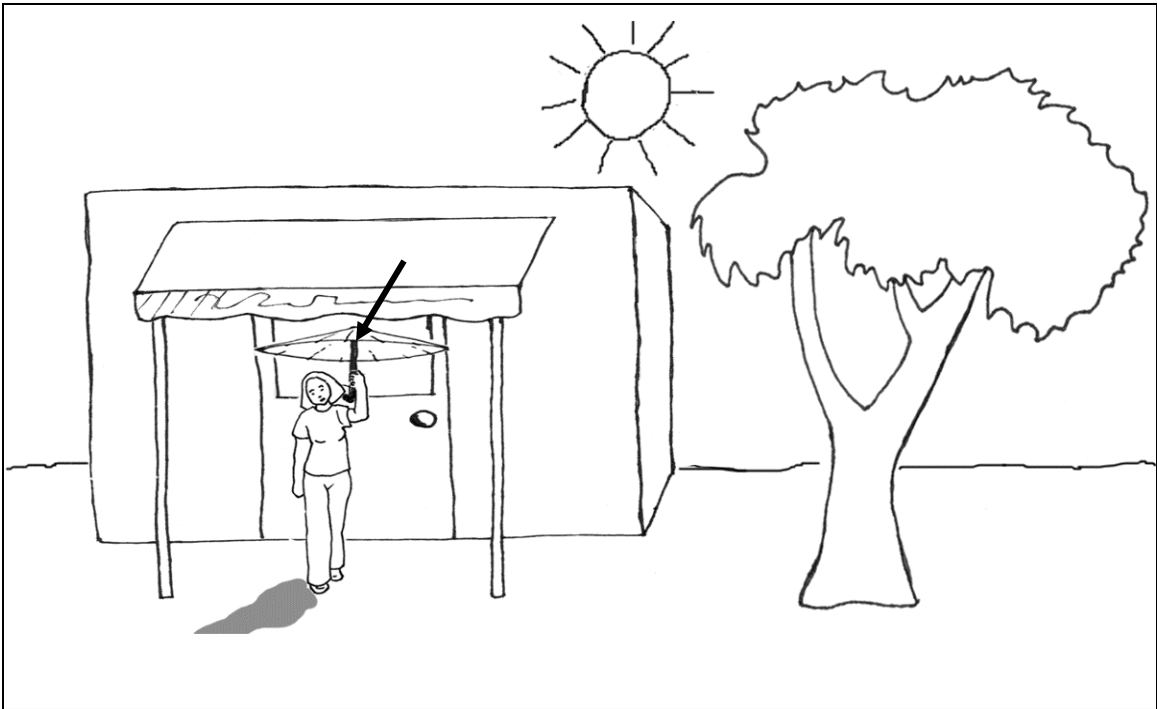

Problem 3-2a

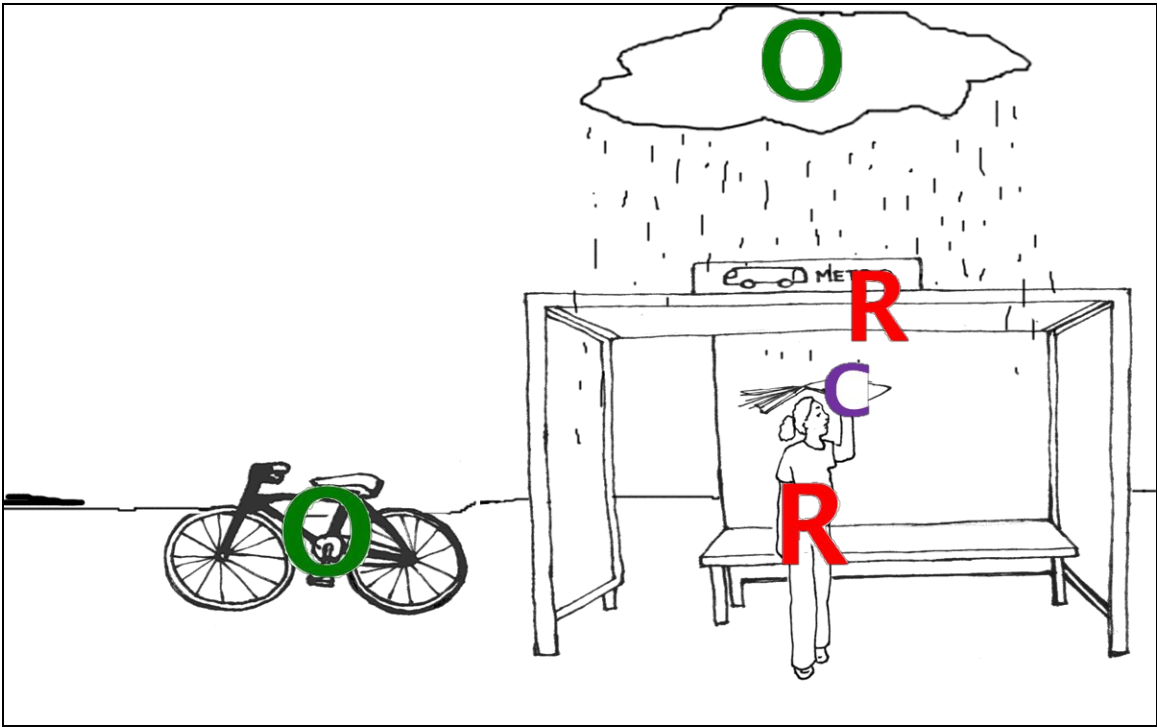
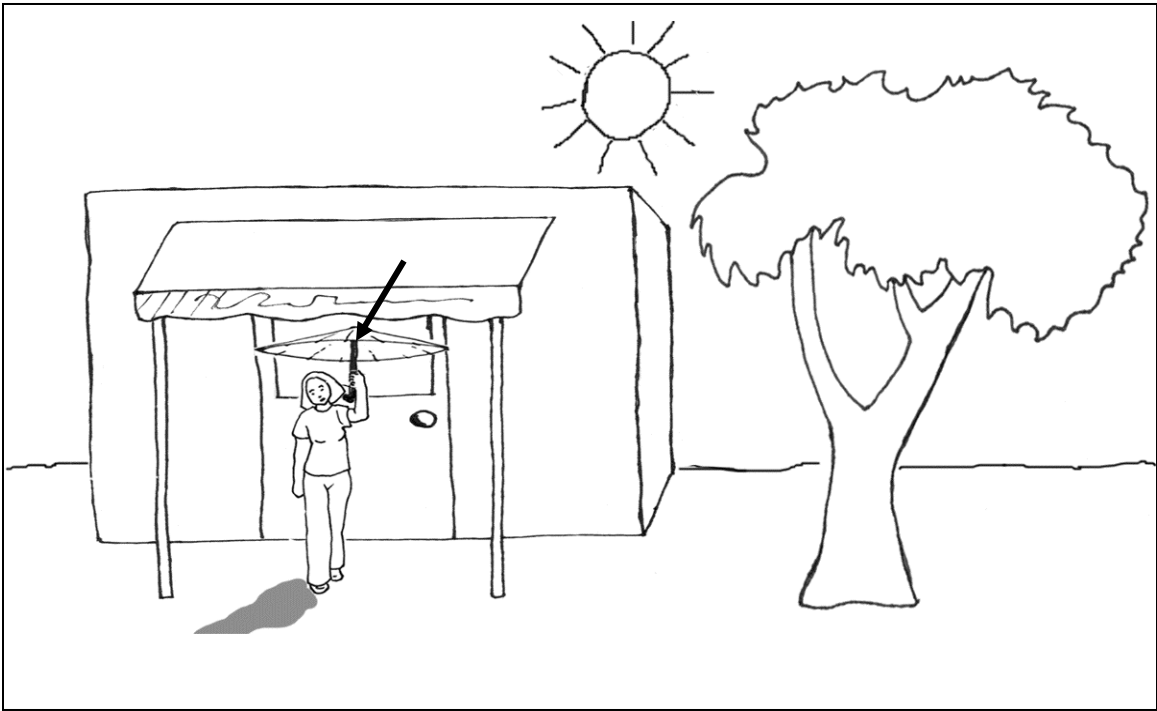

Problem 3-2b

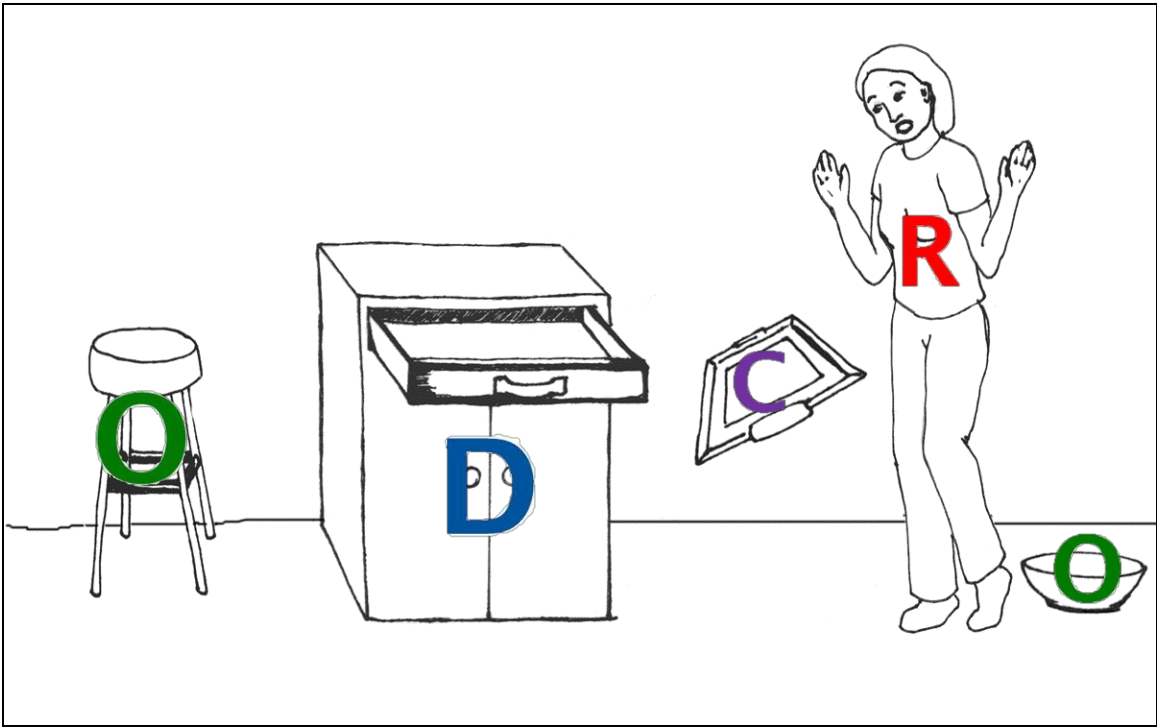
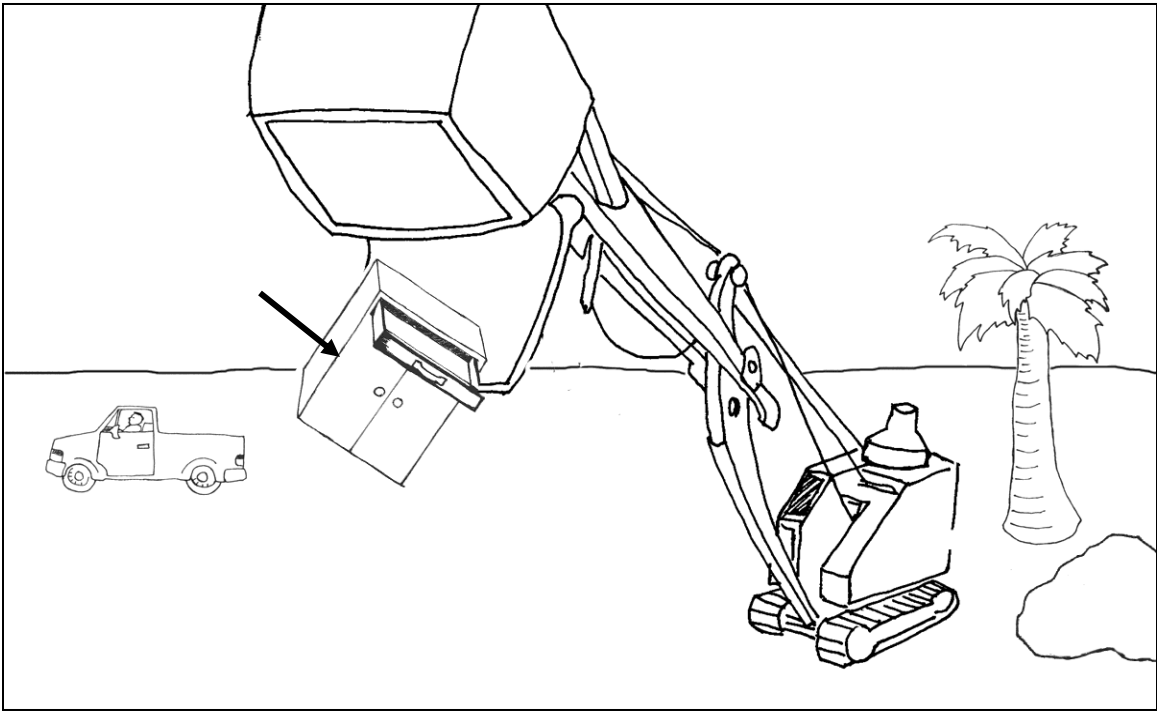

Problem 4-1a

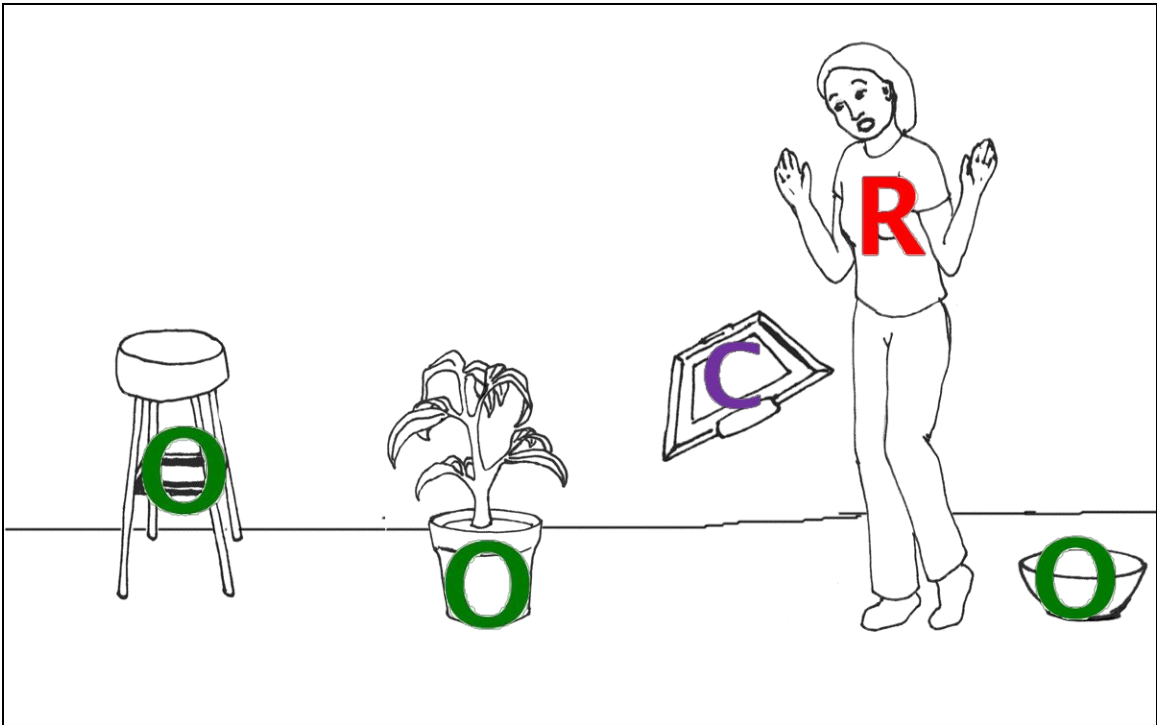
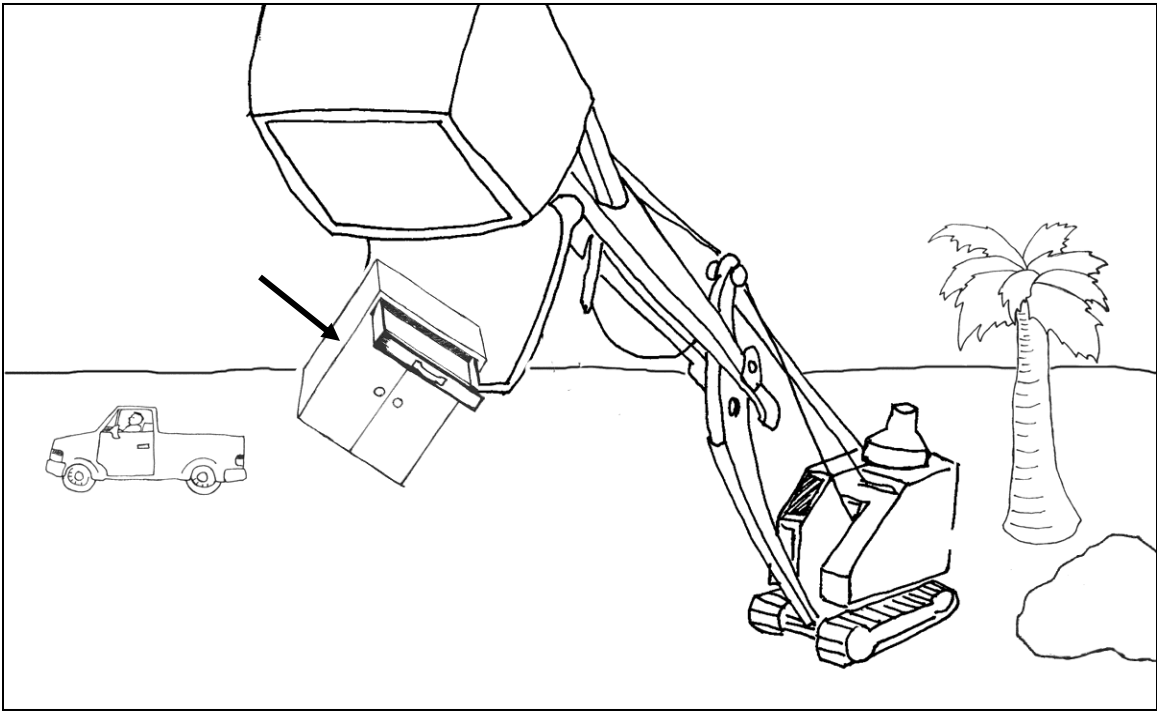

Problem 4-1 b

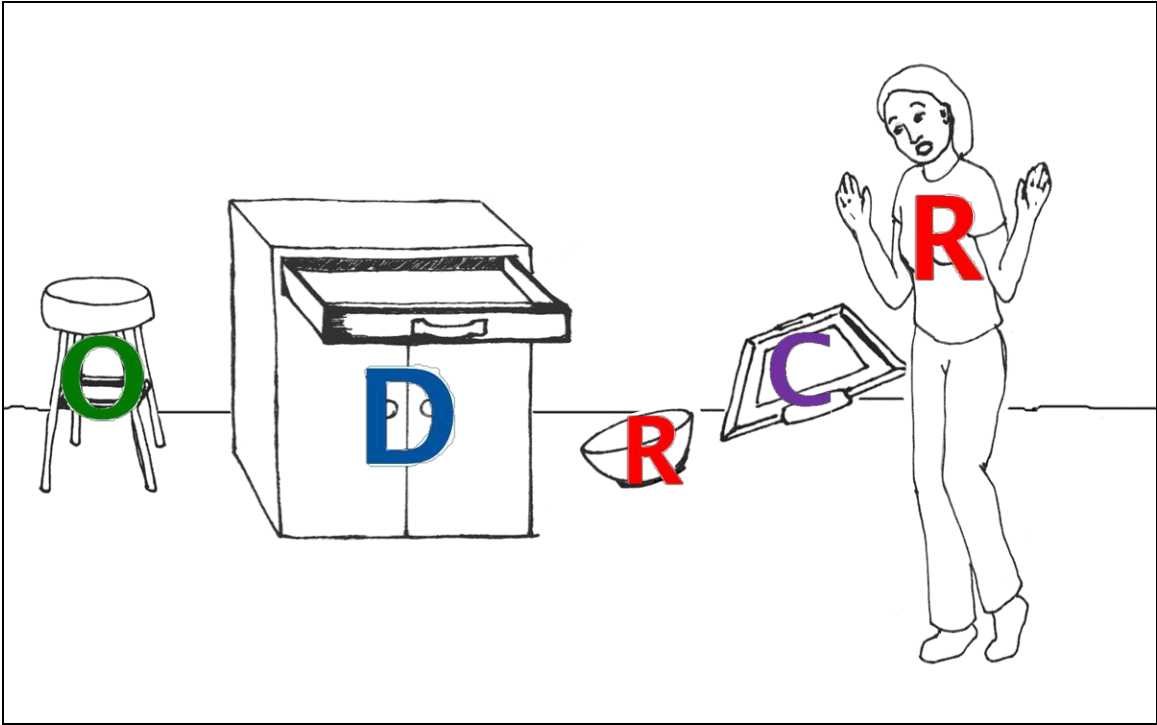
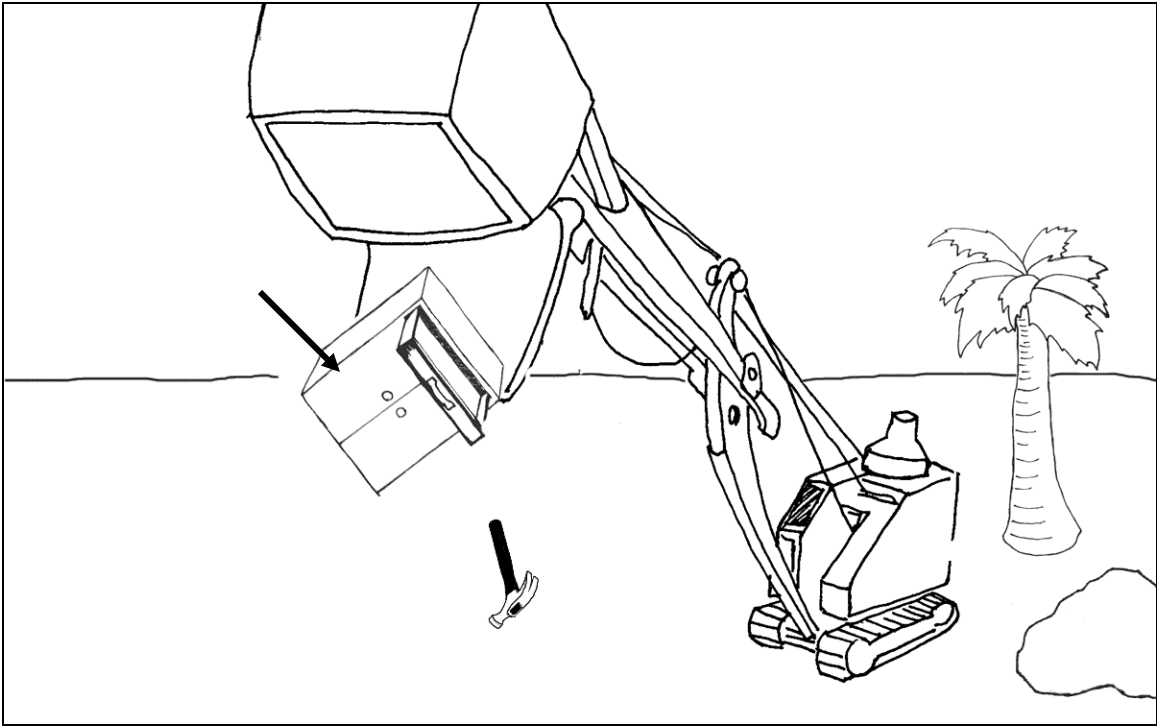

Problem 4-2a

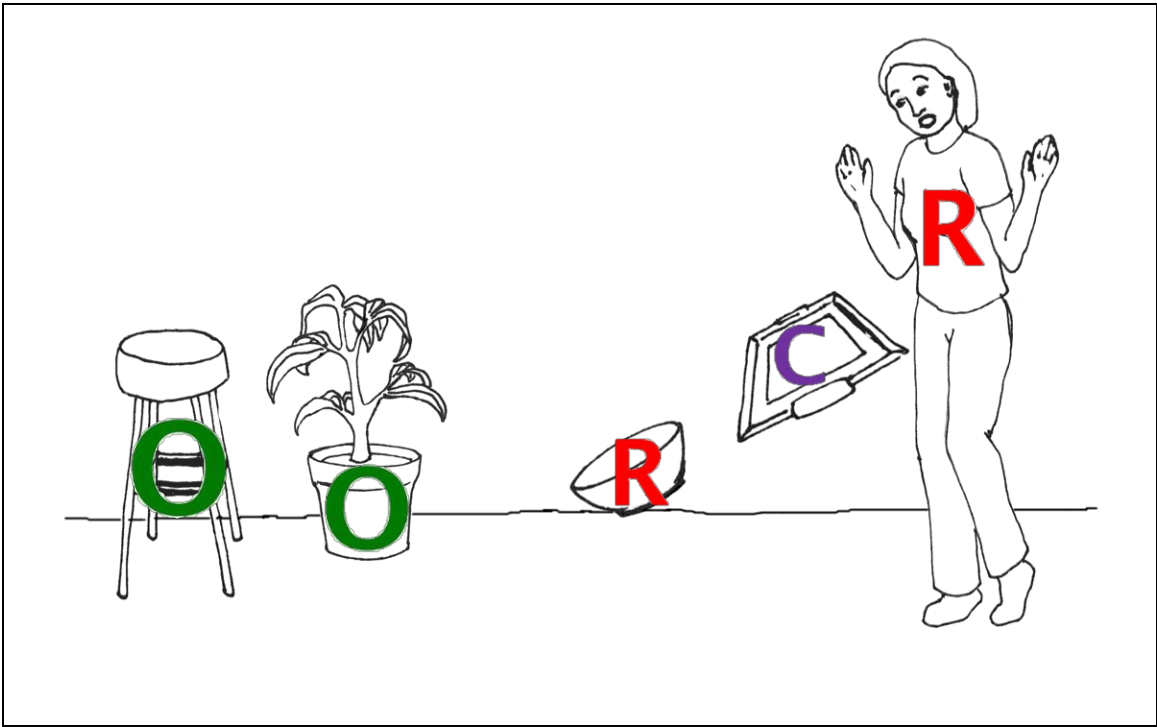
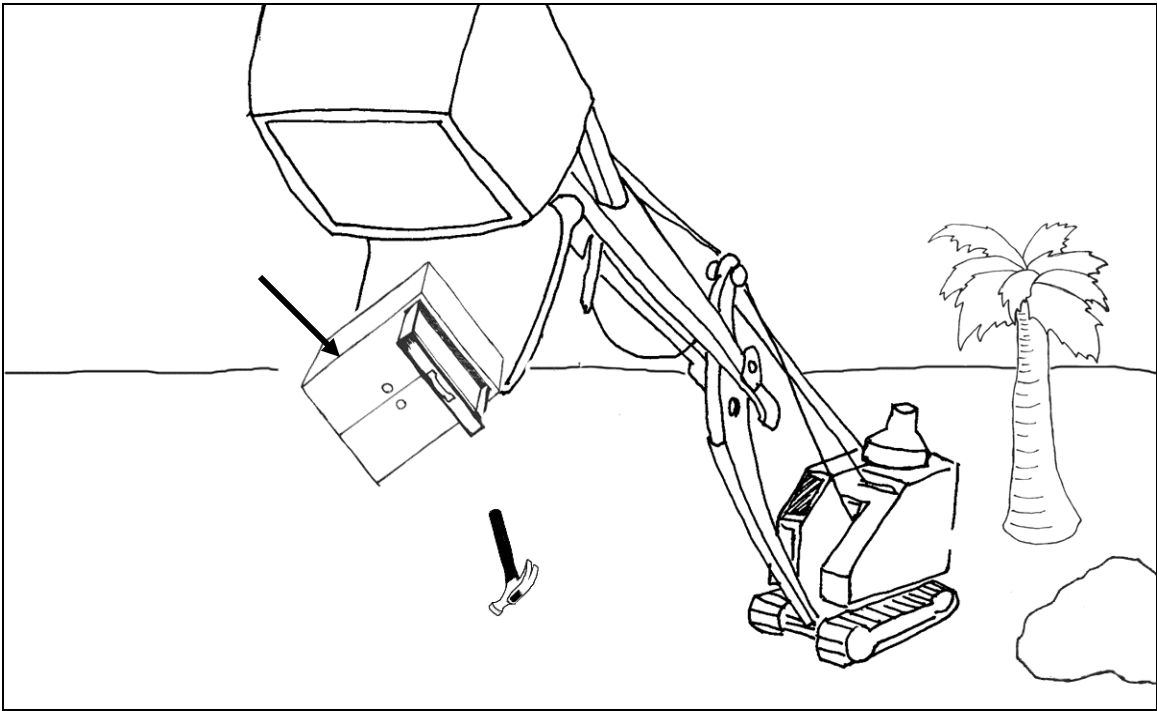

Problem 4-2b

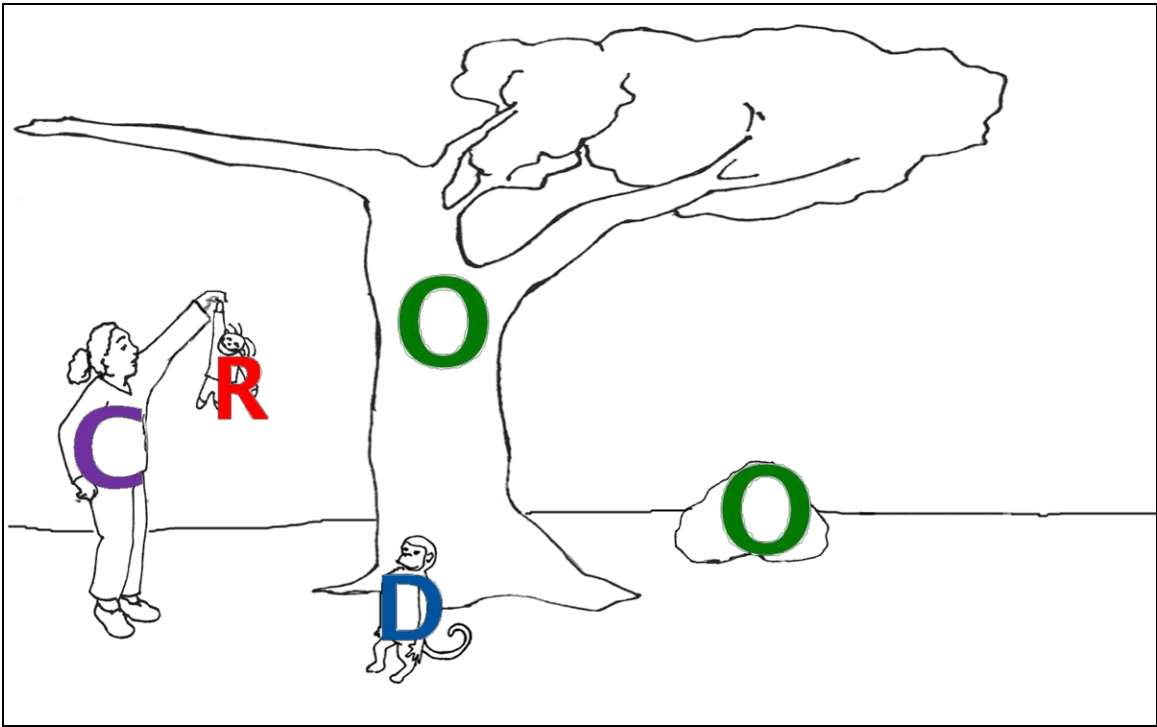
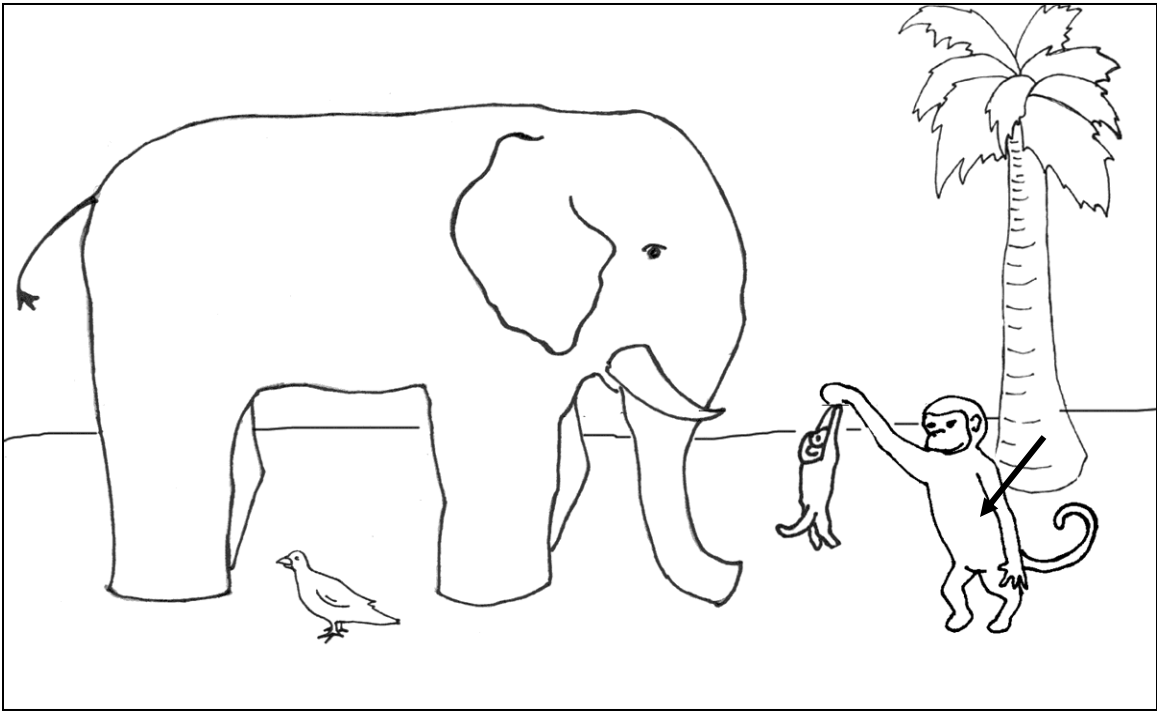

Problem 5-1a



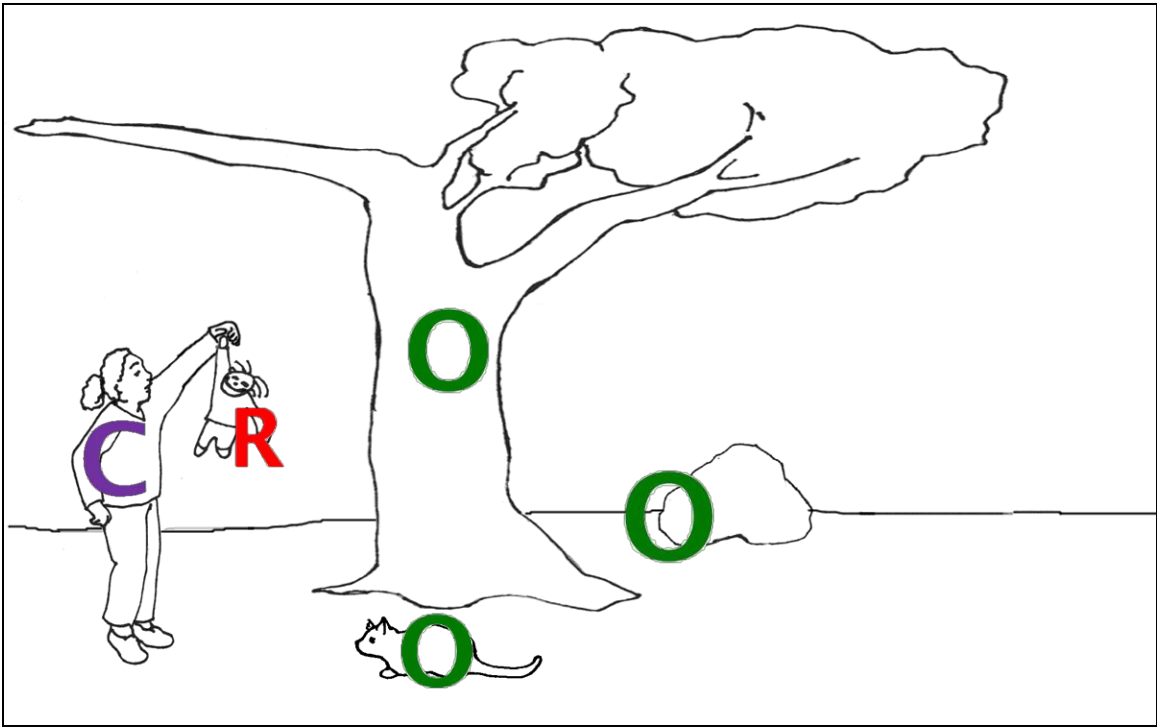
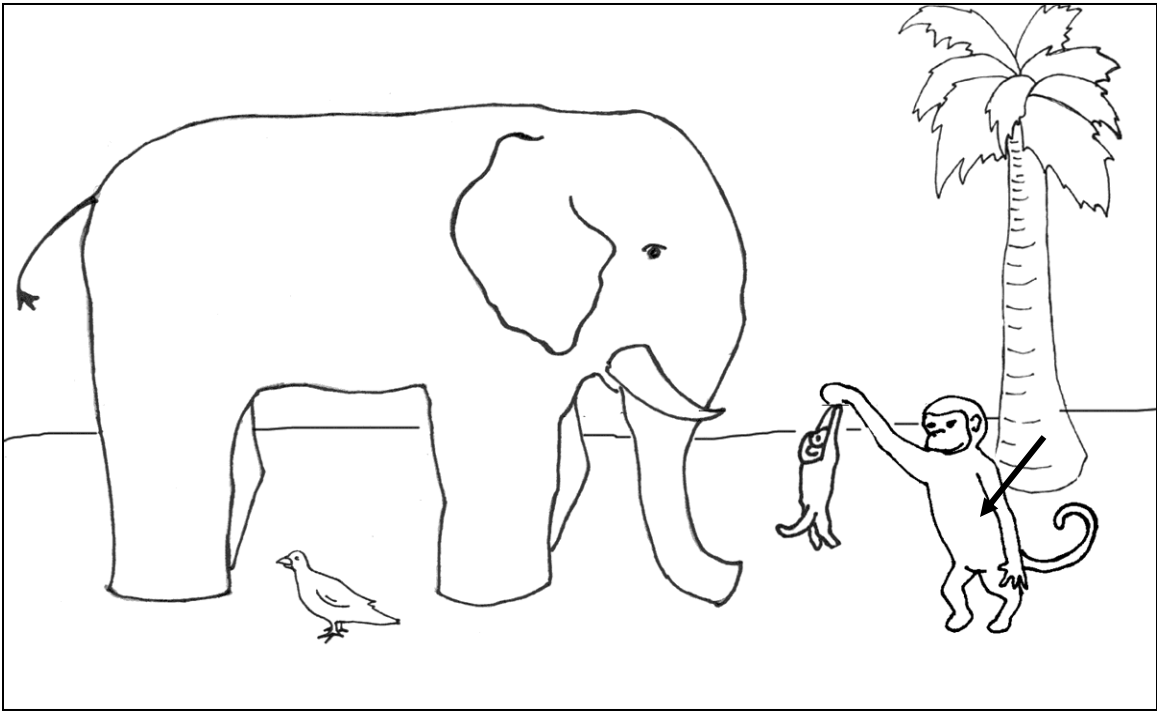

Problem 5-1 b

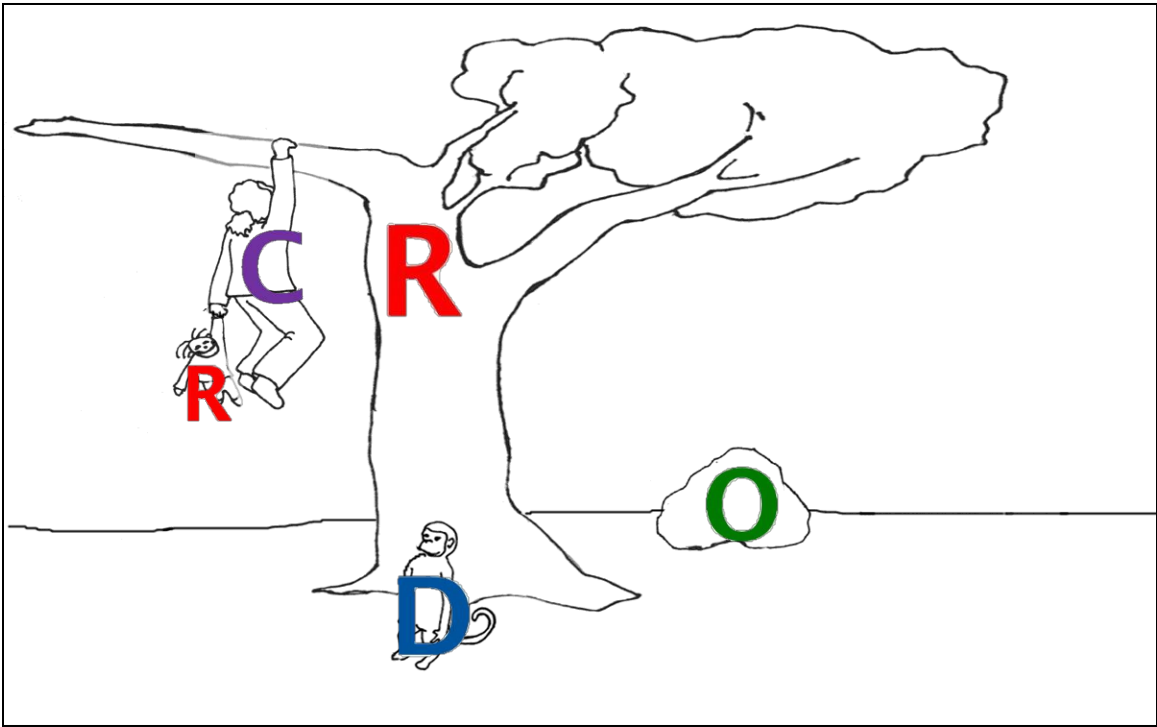
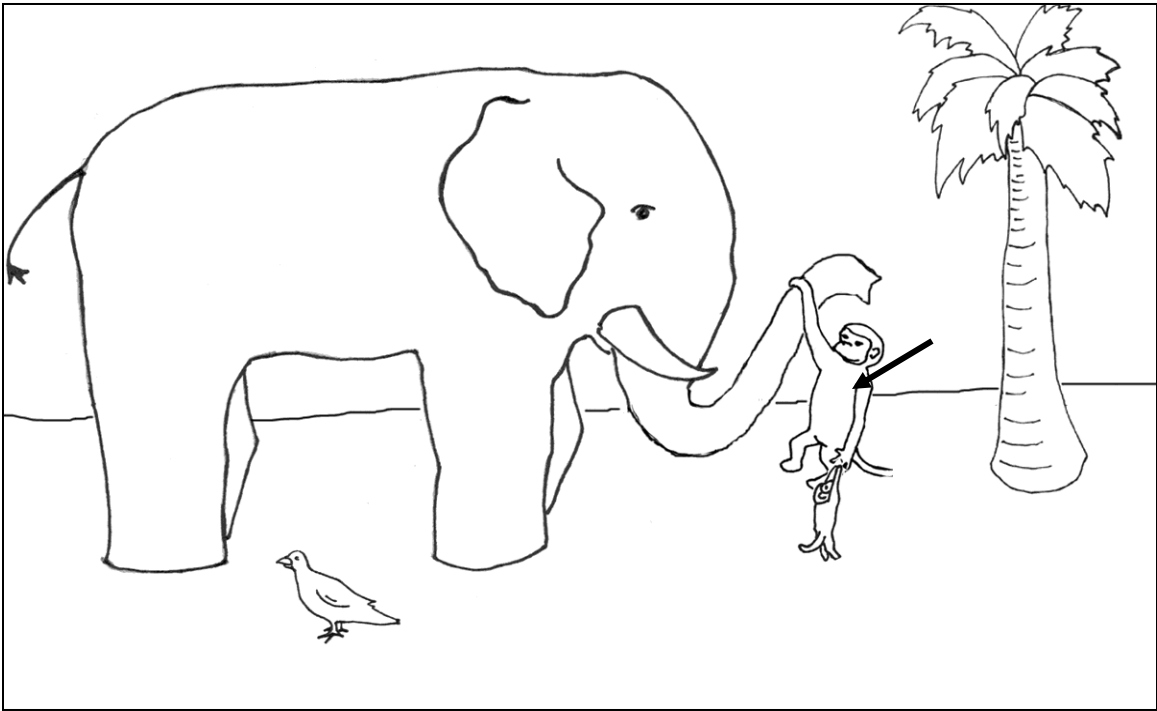

Problem 5-2a

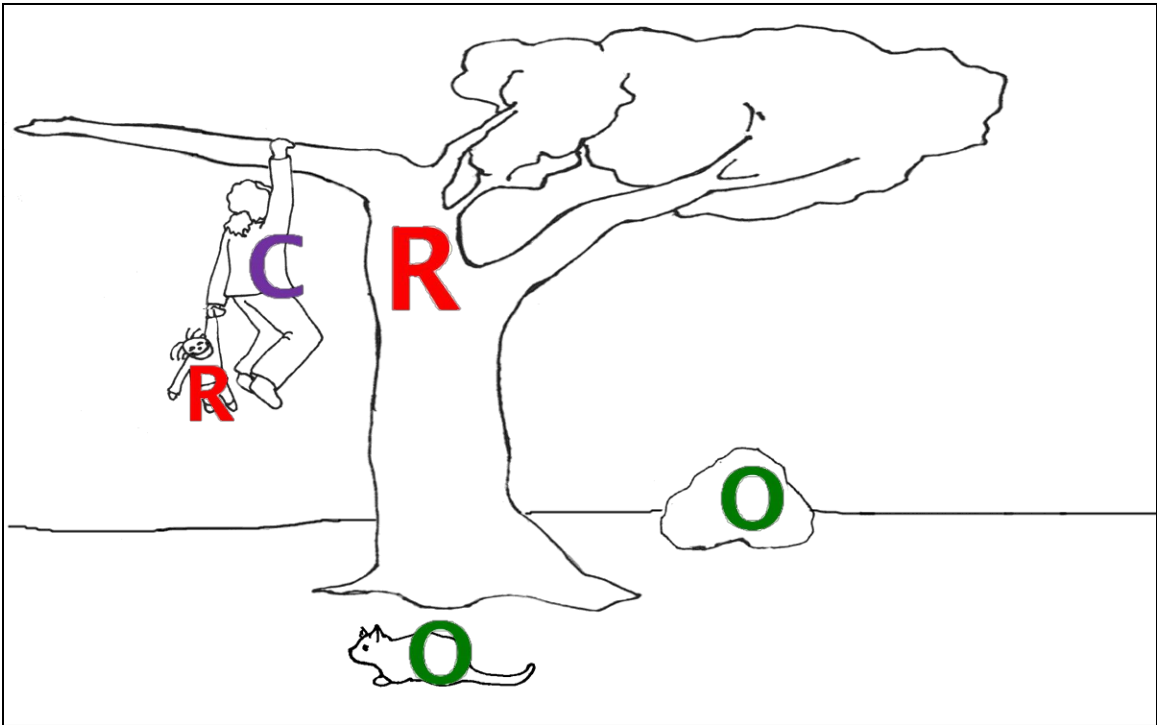
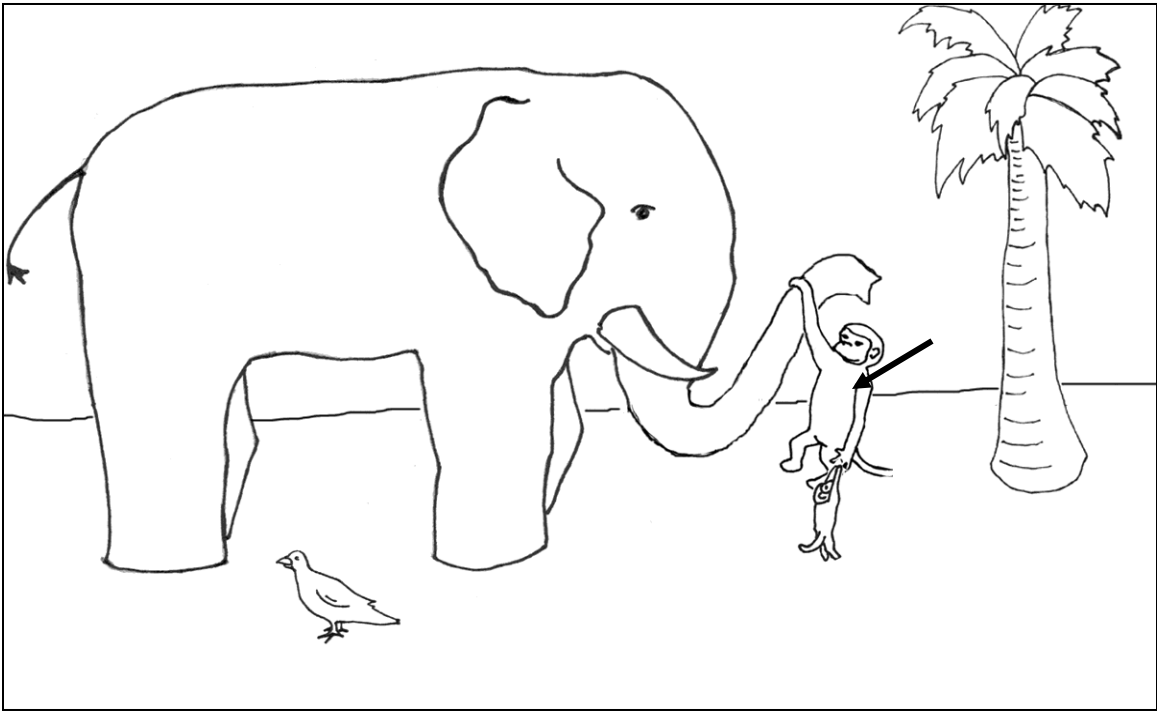

Problem 5-2b

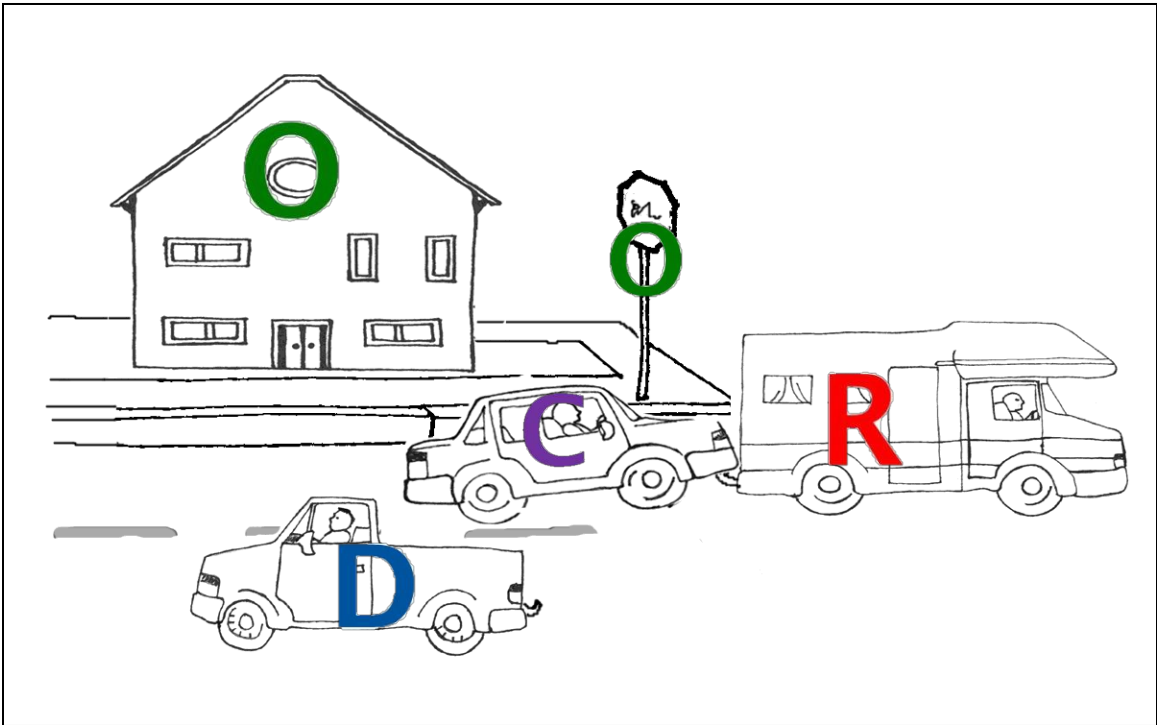
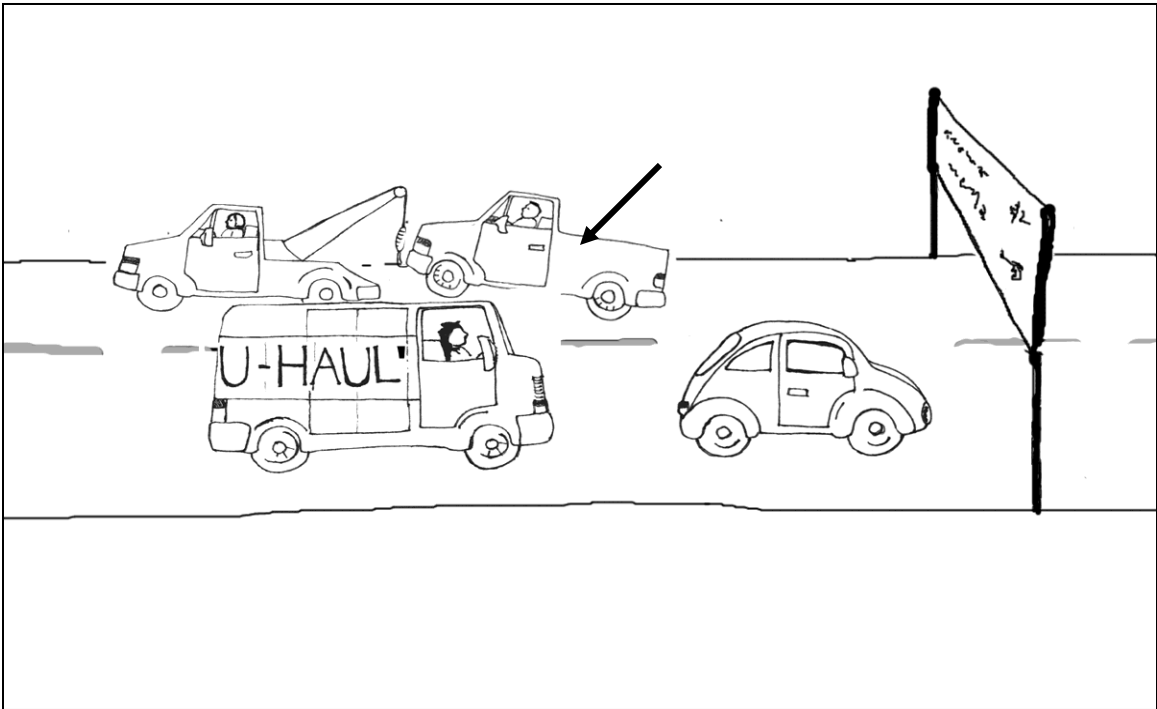

Problem 6-1a

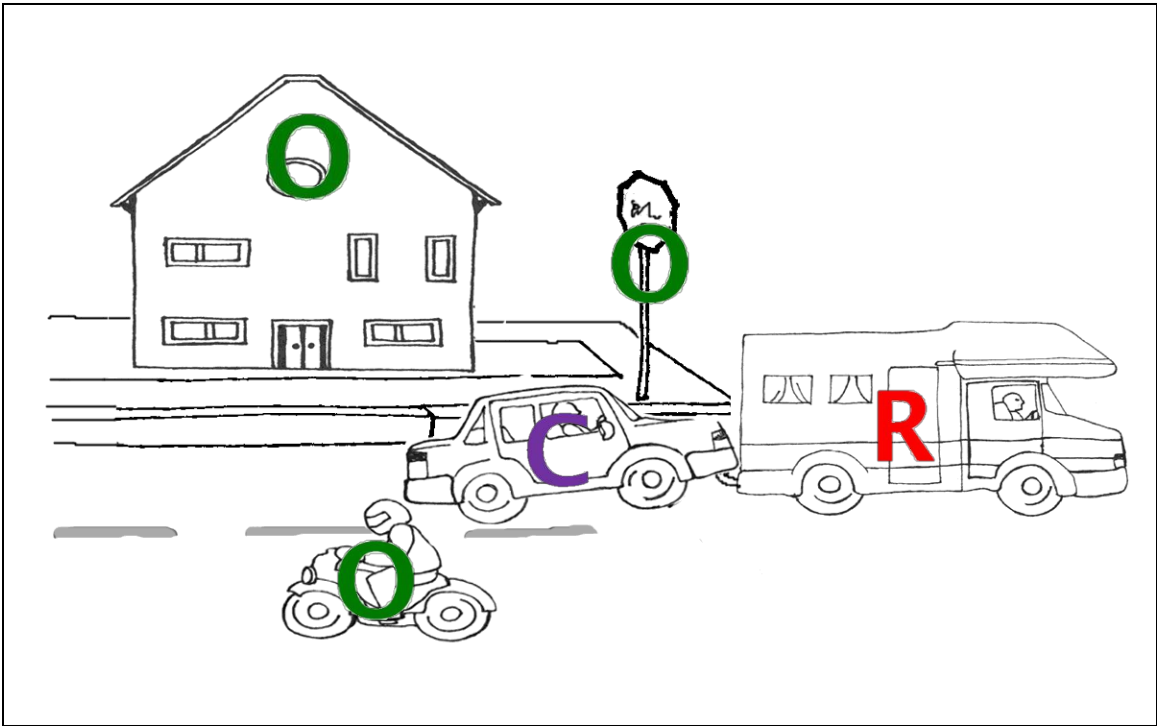
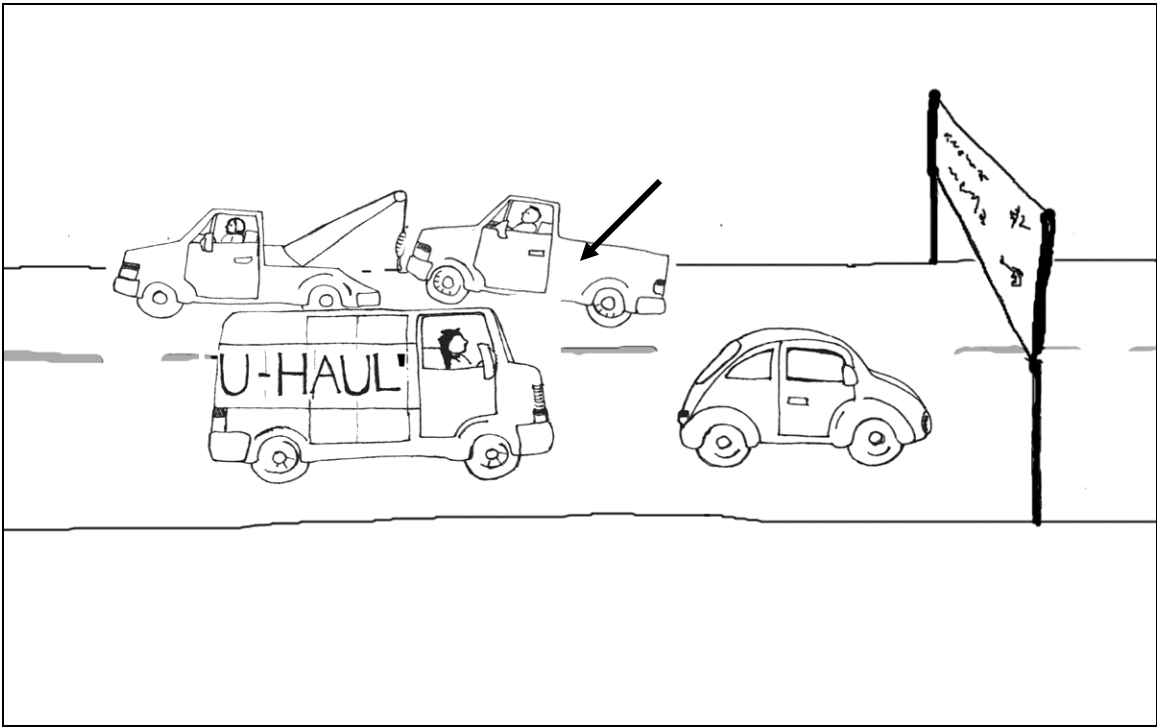

Problem 6-1 b

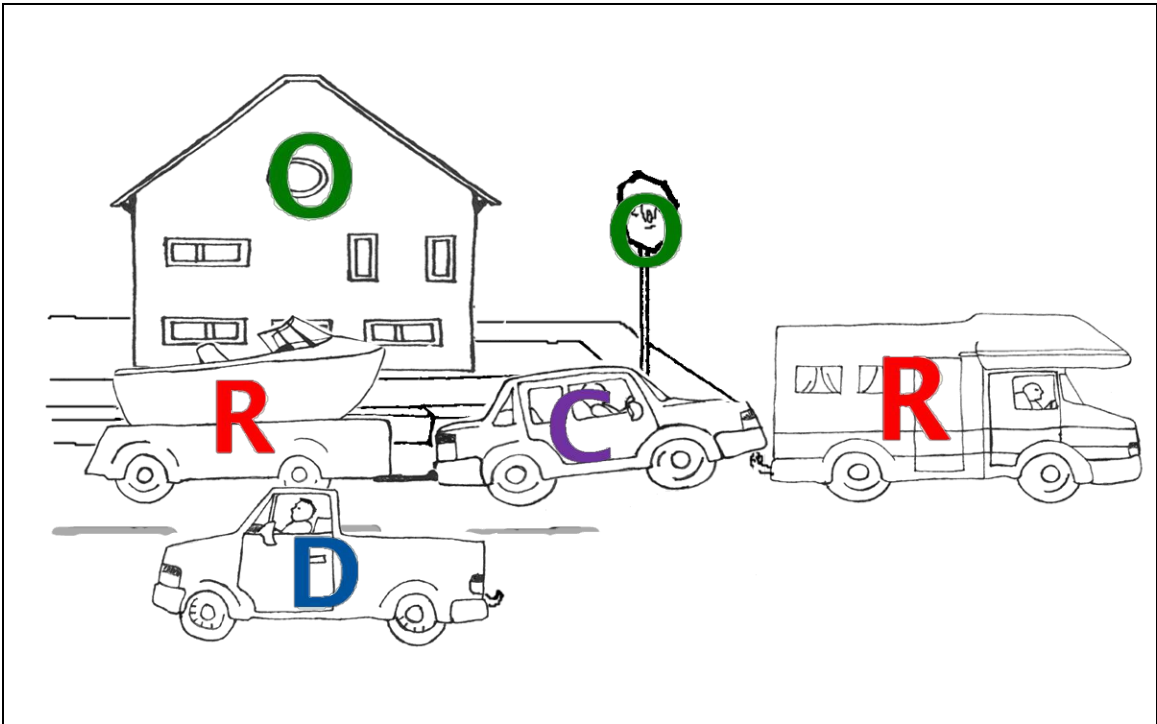
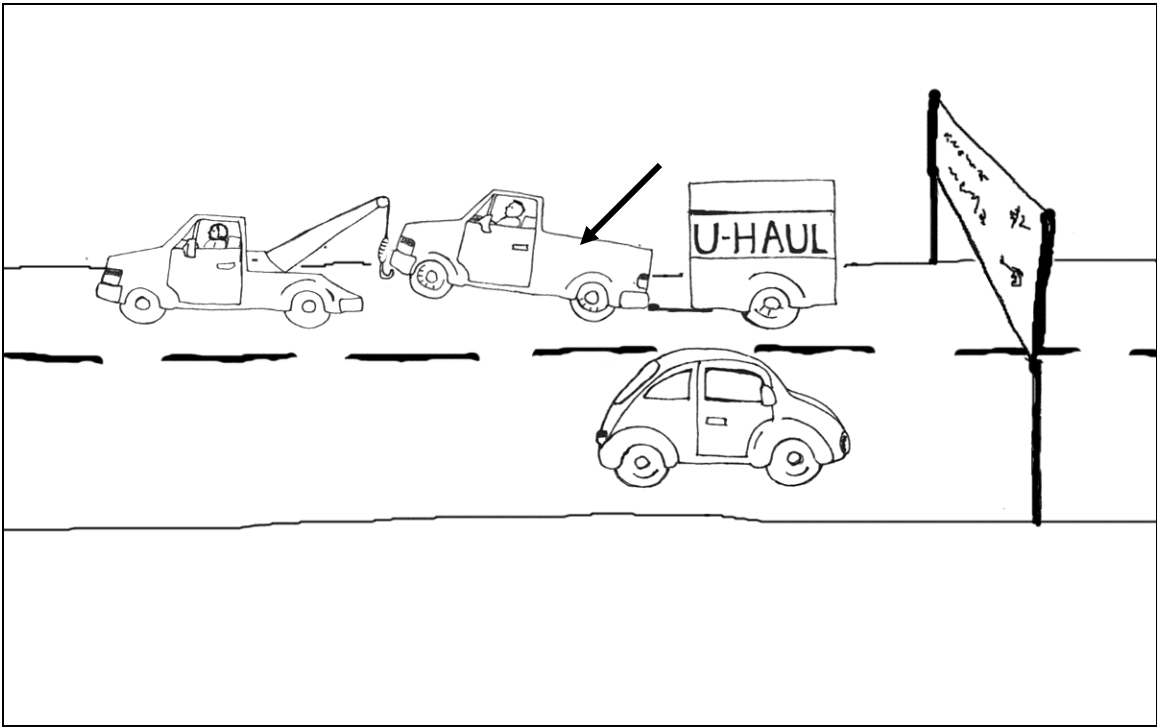

Problem 6-2a

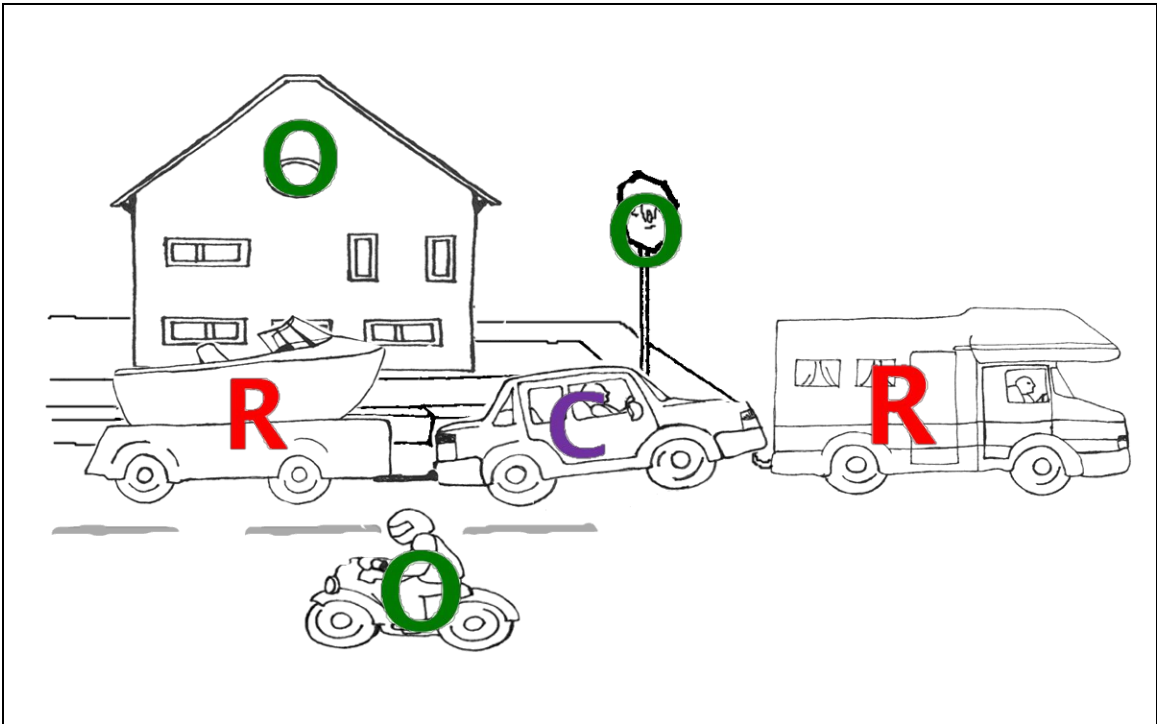
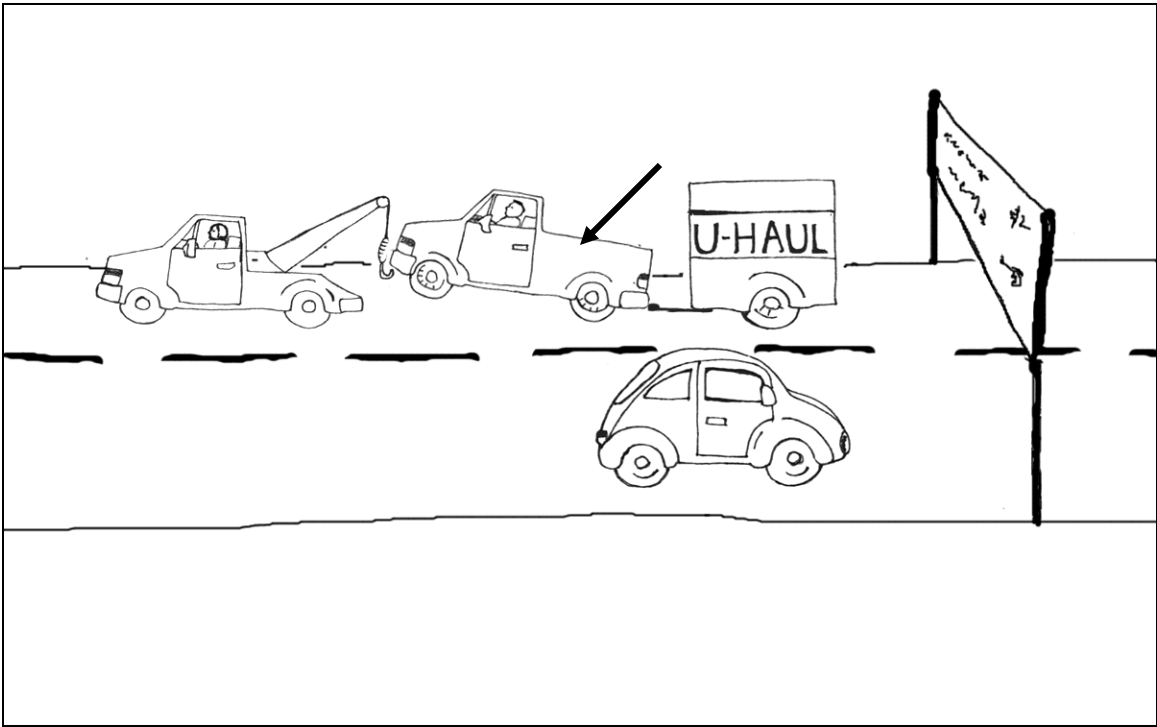

Problem 6-2b

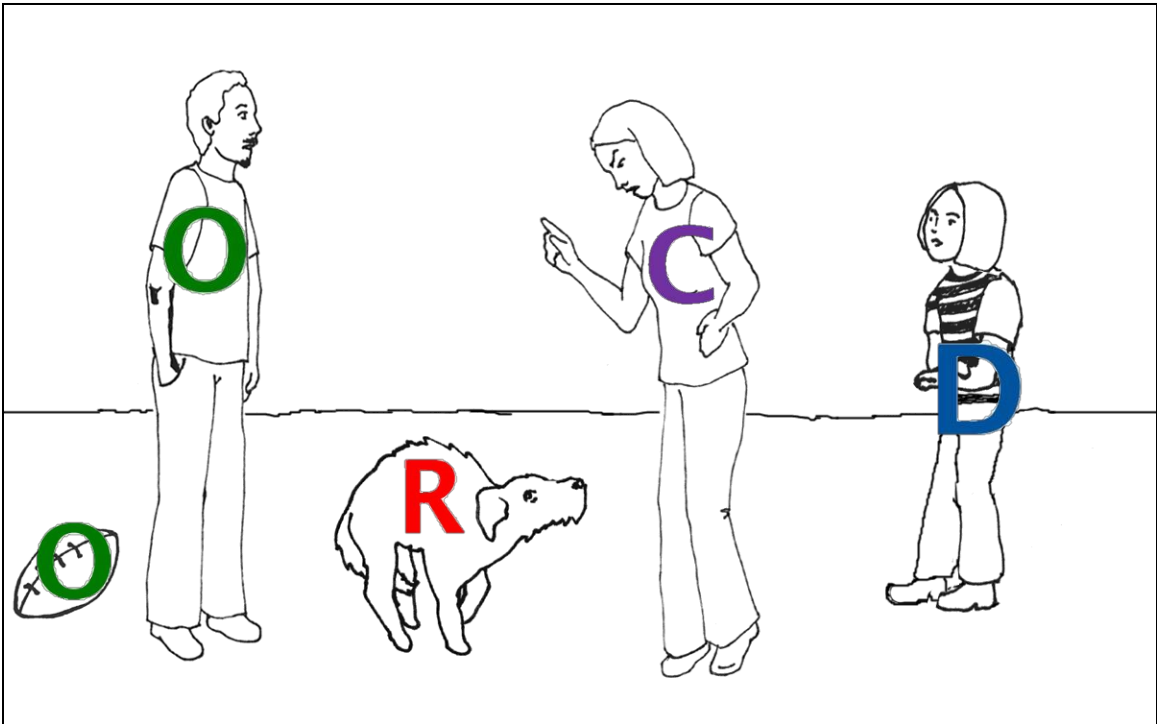
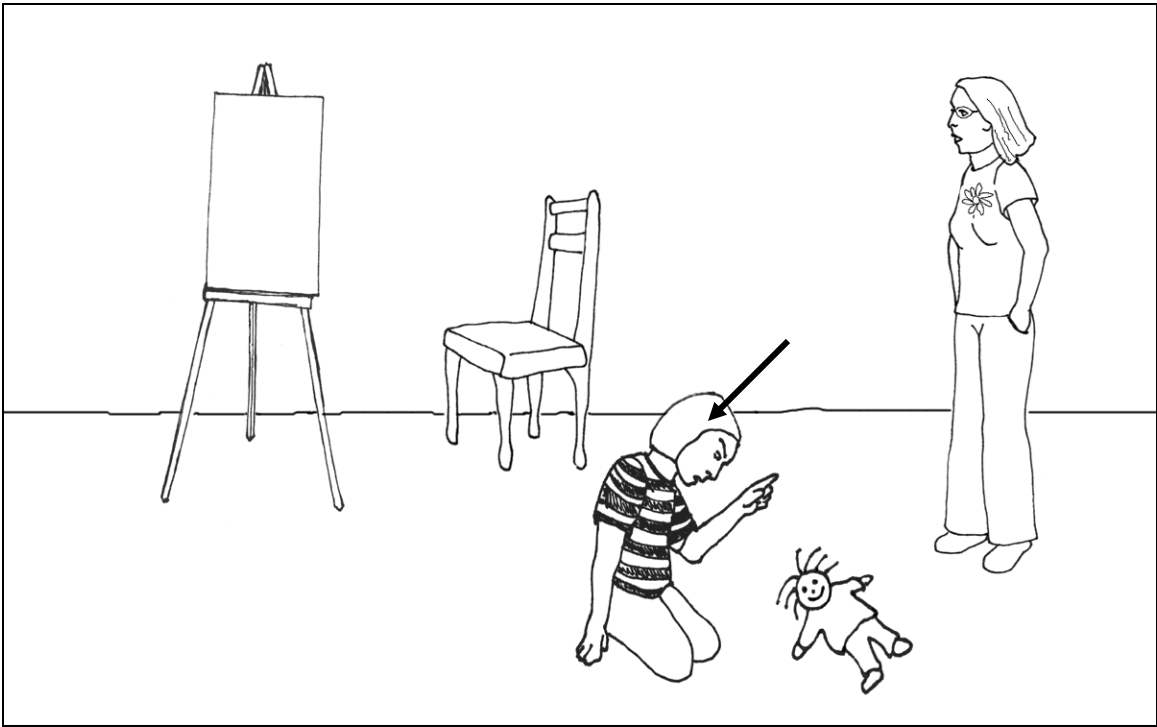

Problem 7-1a



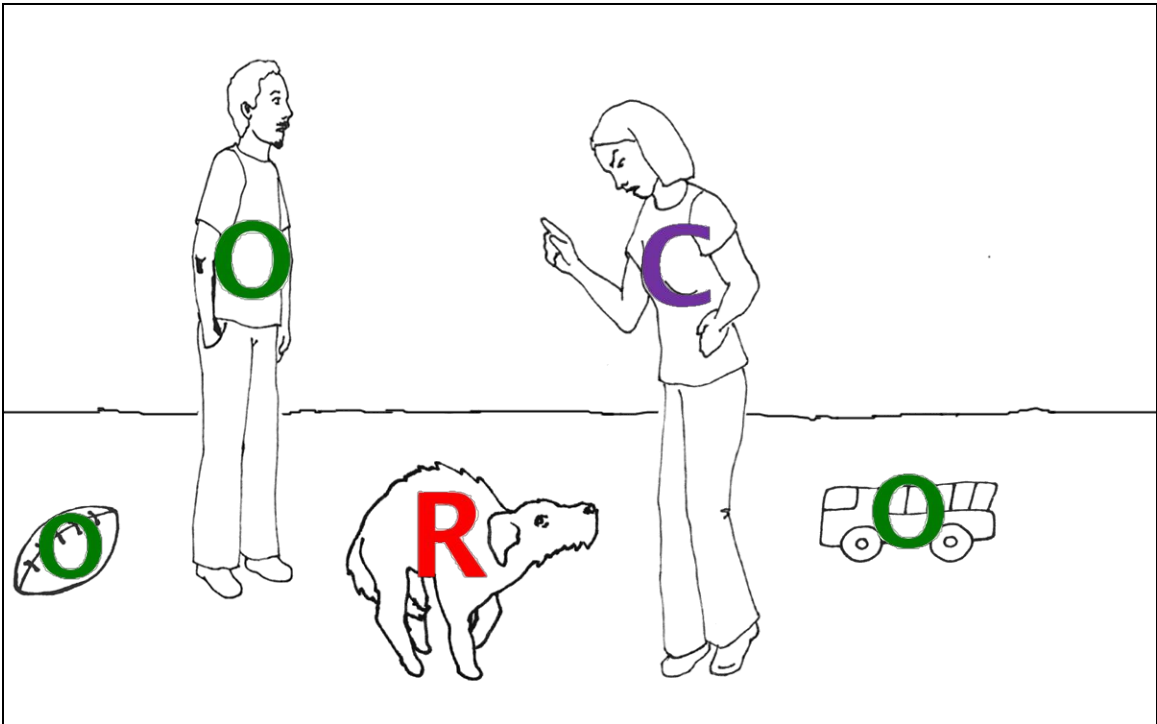
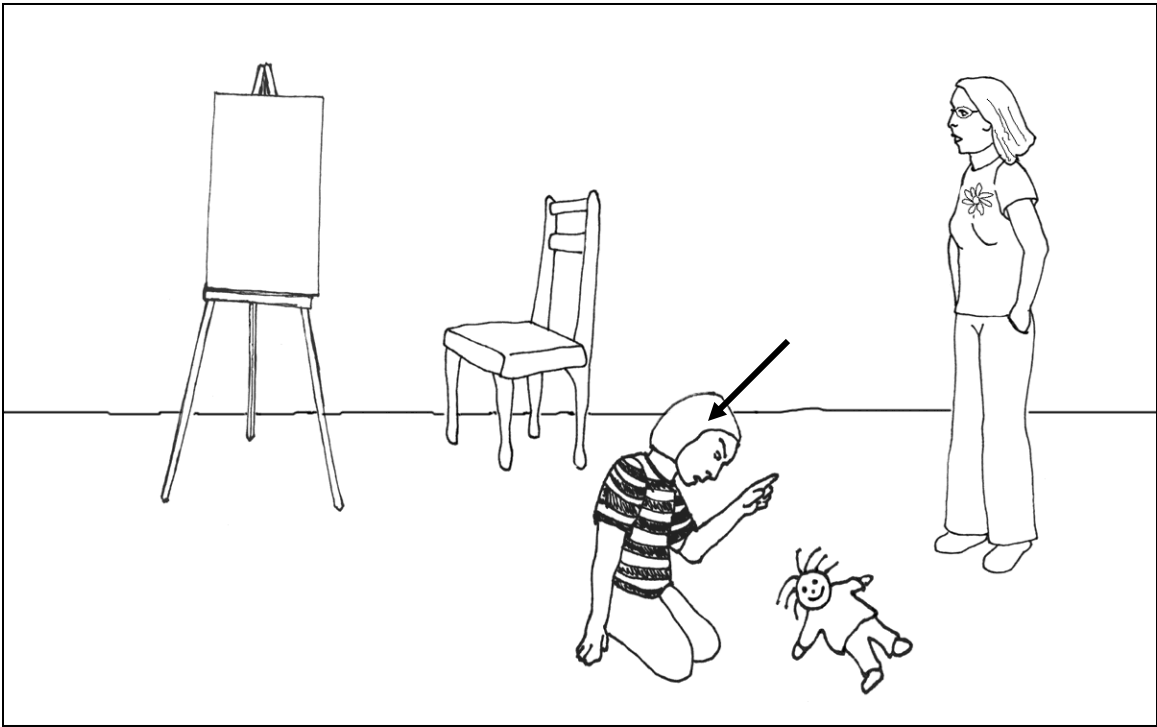

Problem 7-1 b

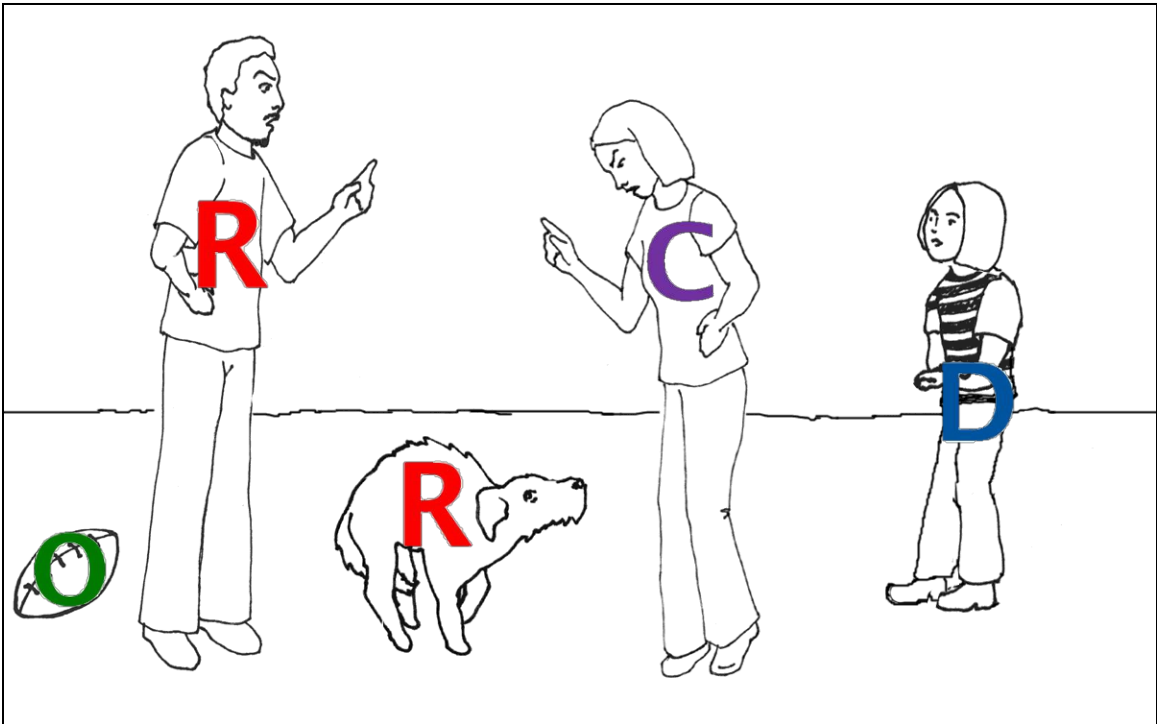
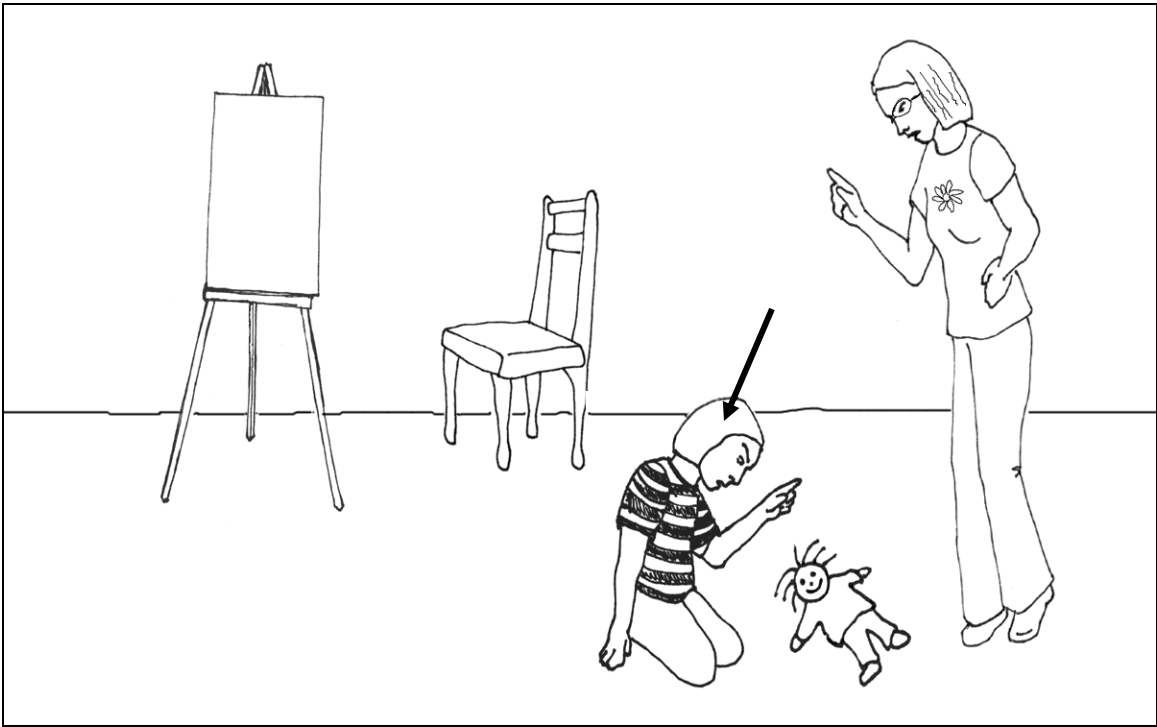

Problem 7-2a

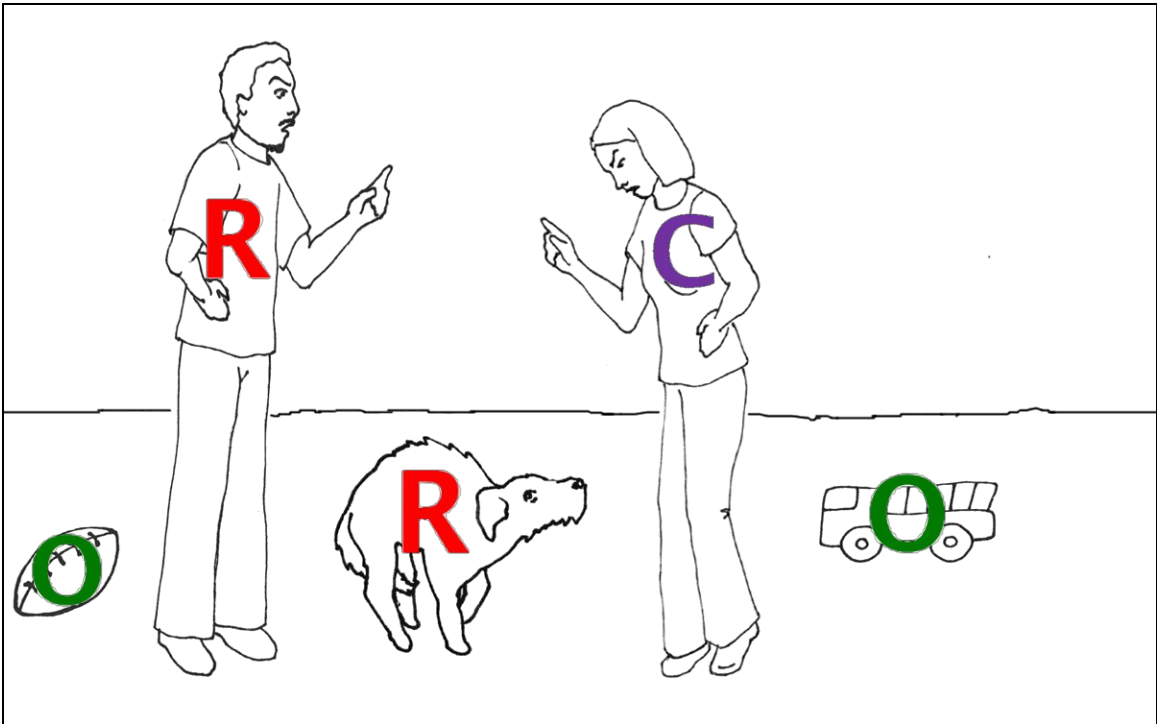
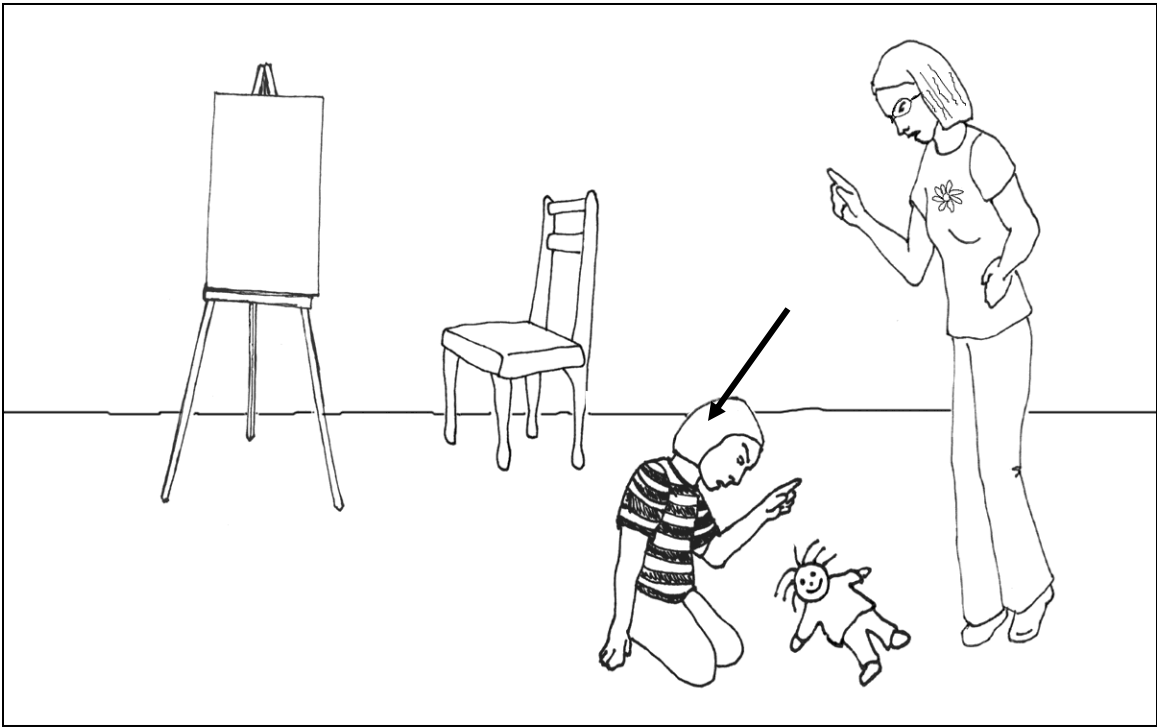

Problem 7-2b

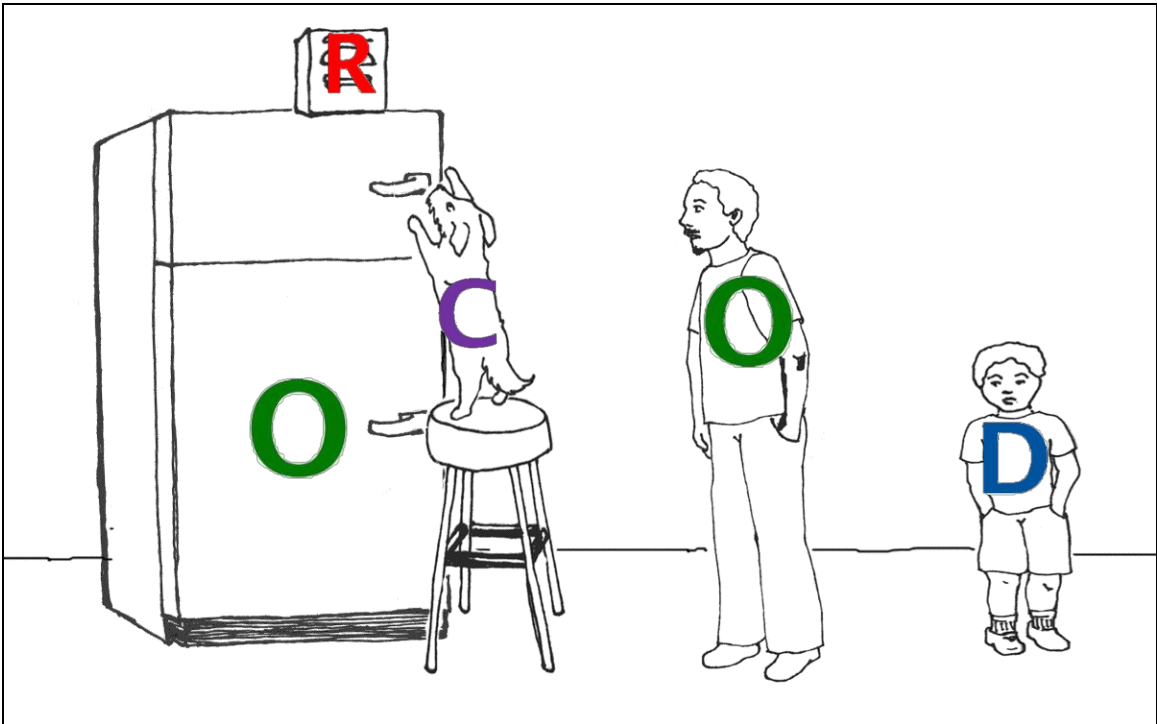
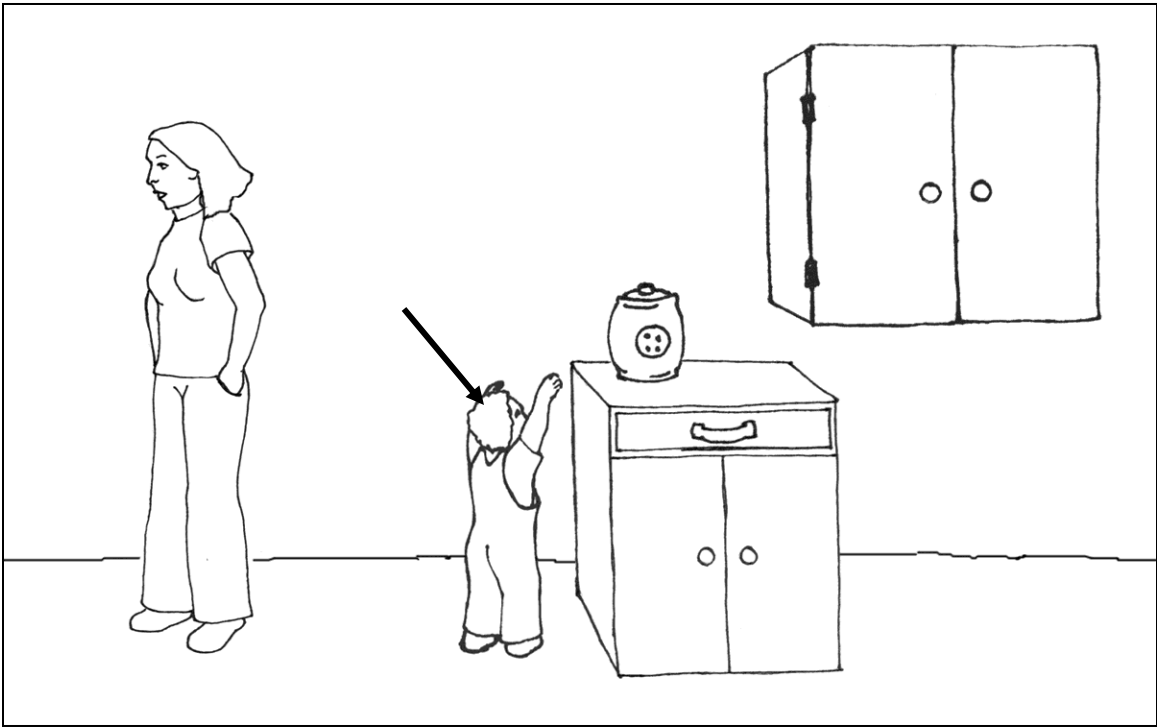

Problem 8-1a

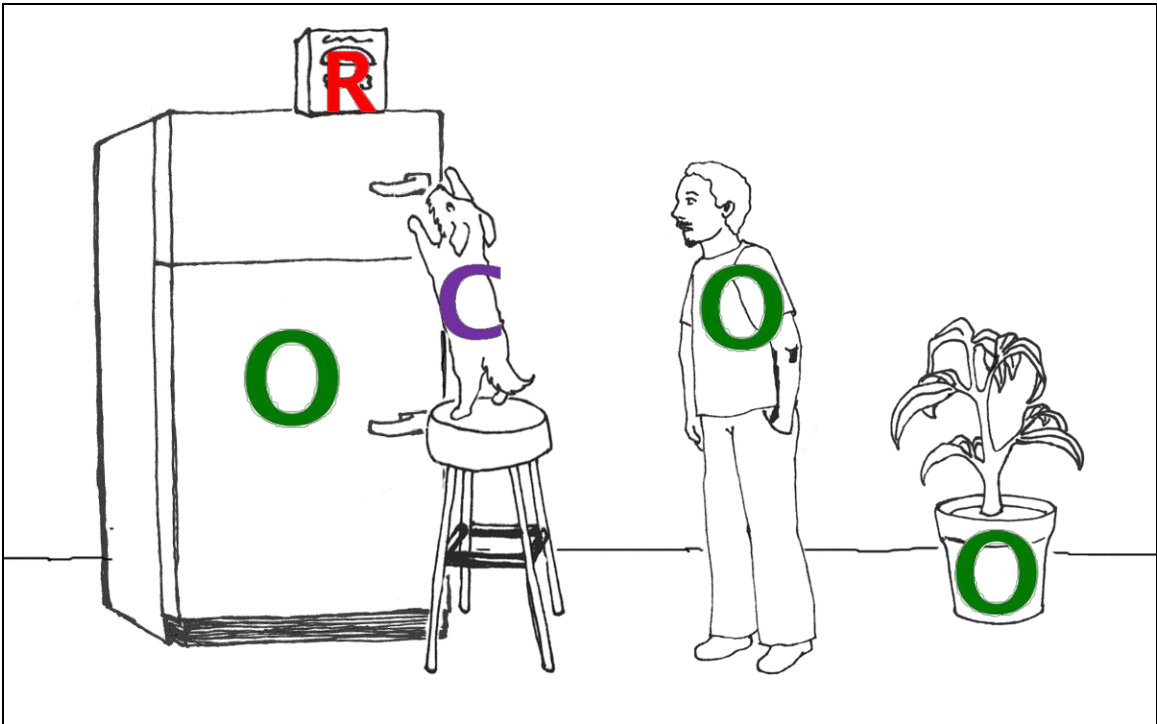
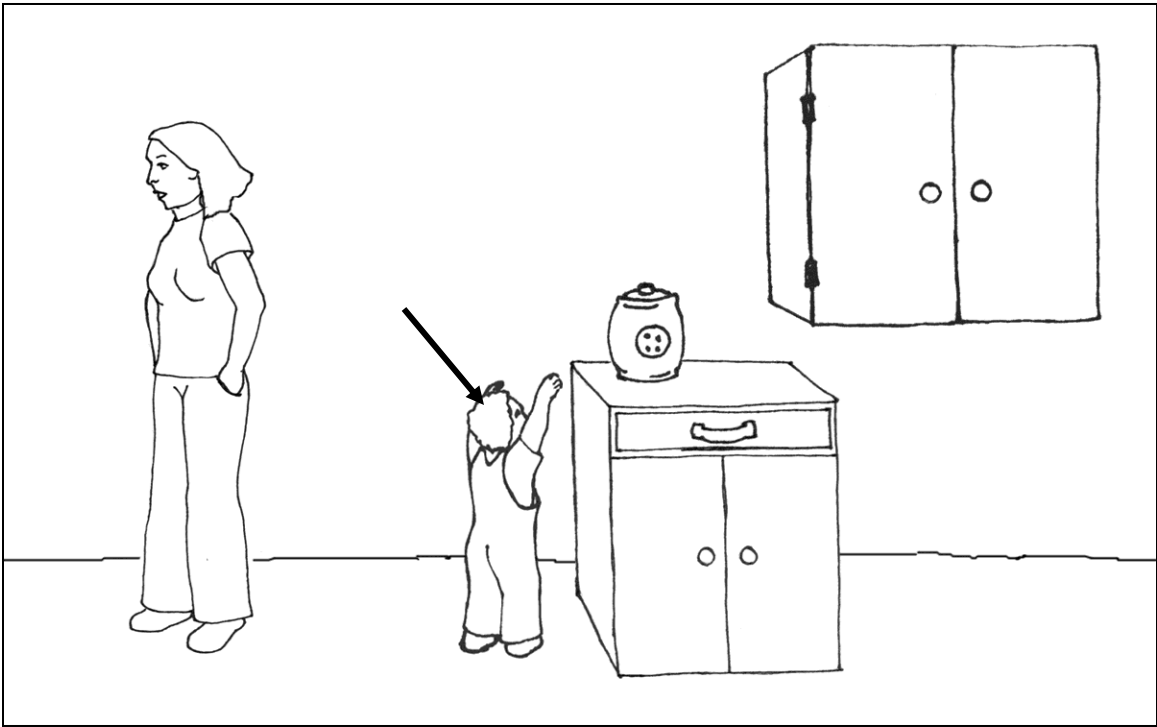

Problem 8-1 b

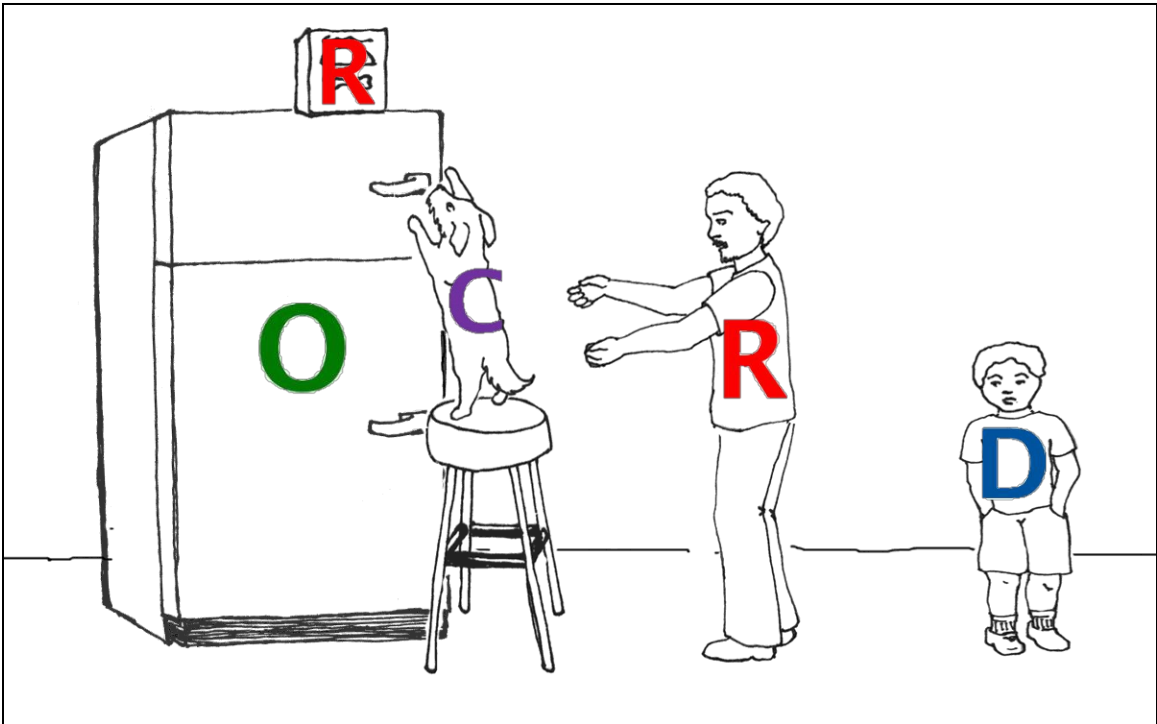
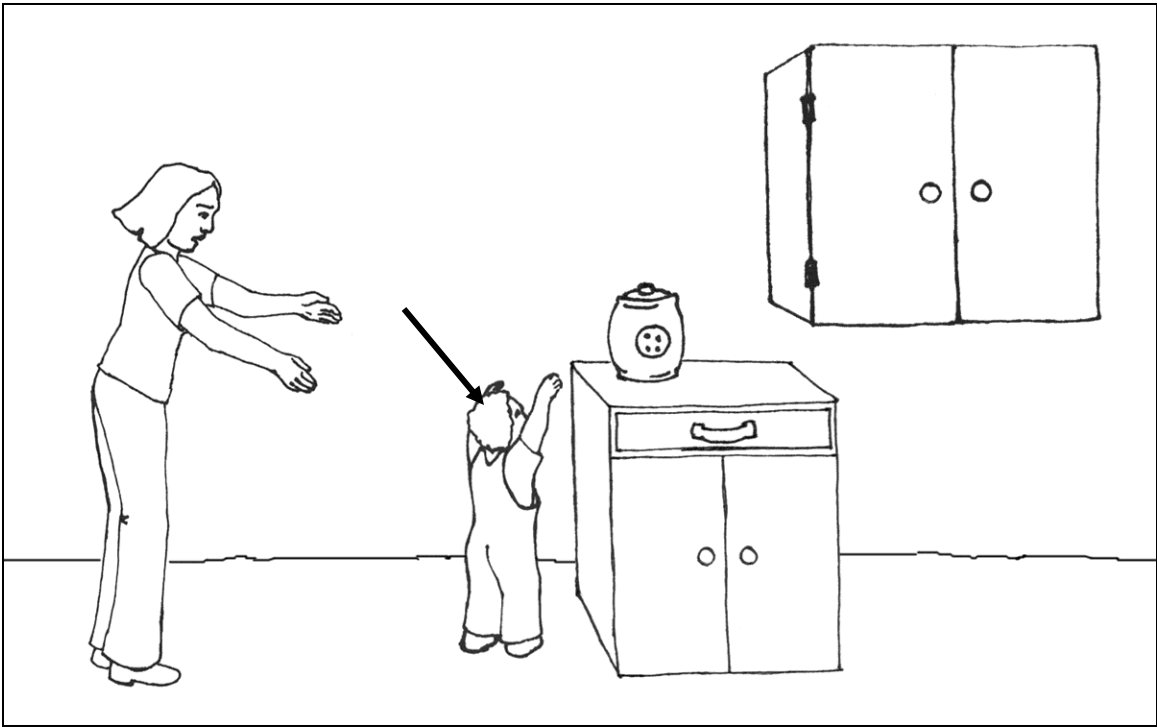

Problem 8-2a

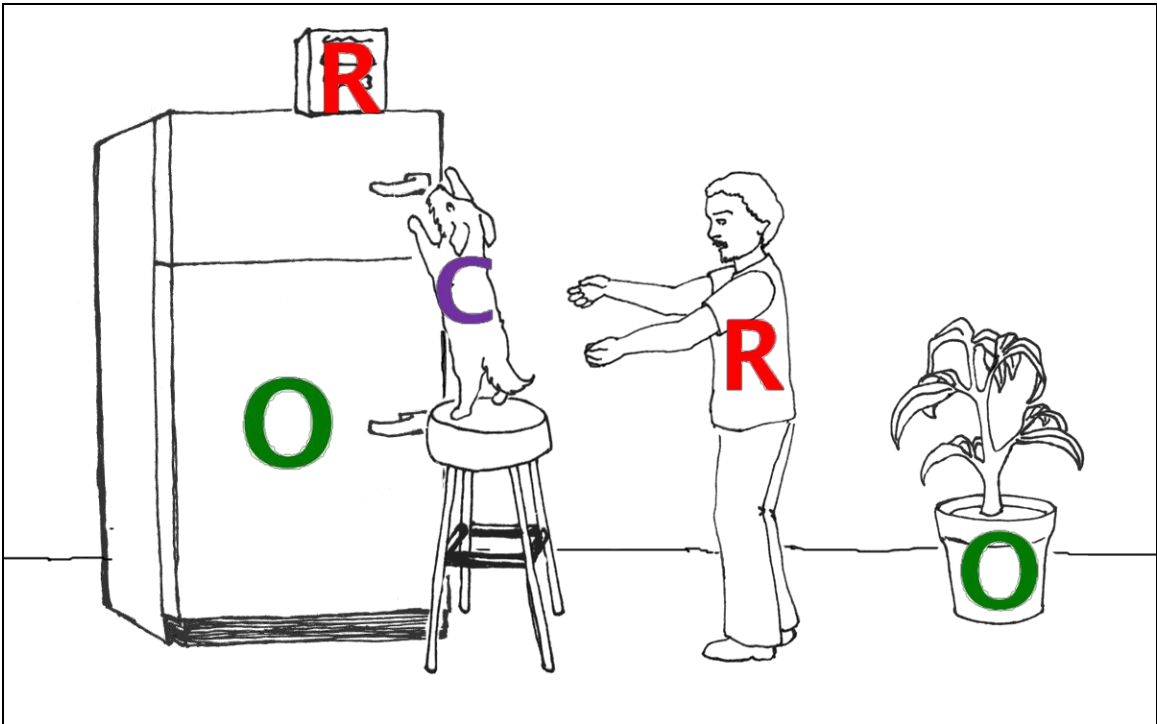
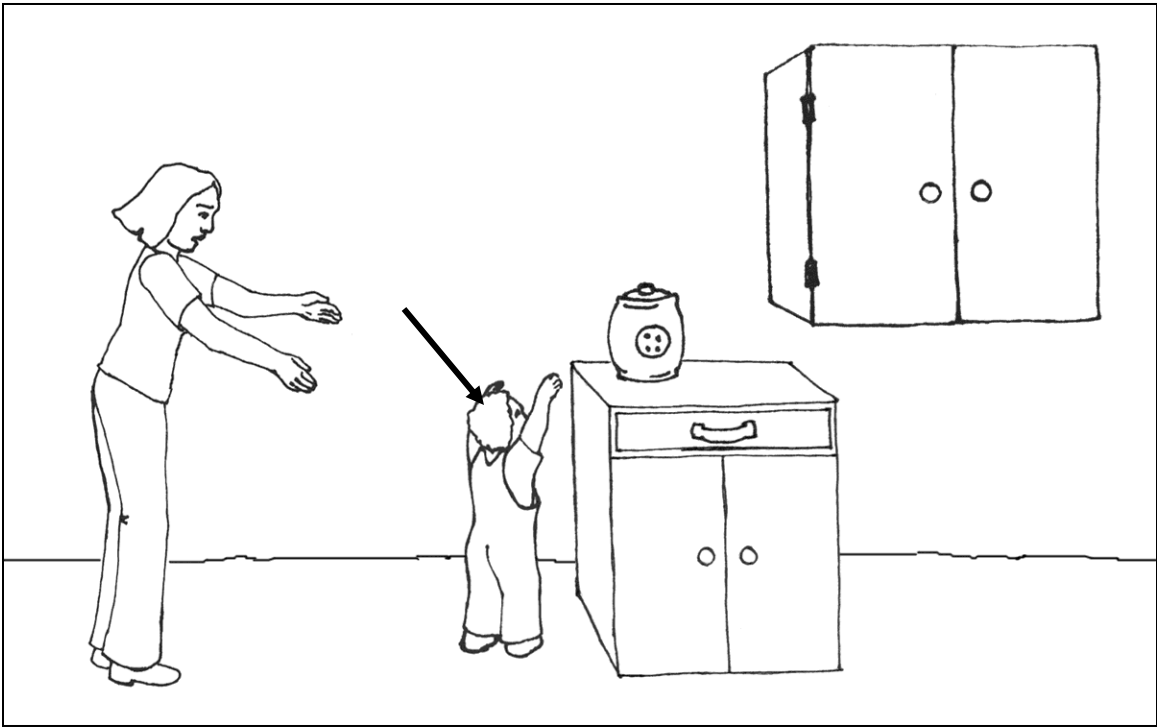

Problem 8-2b

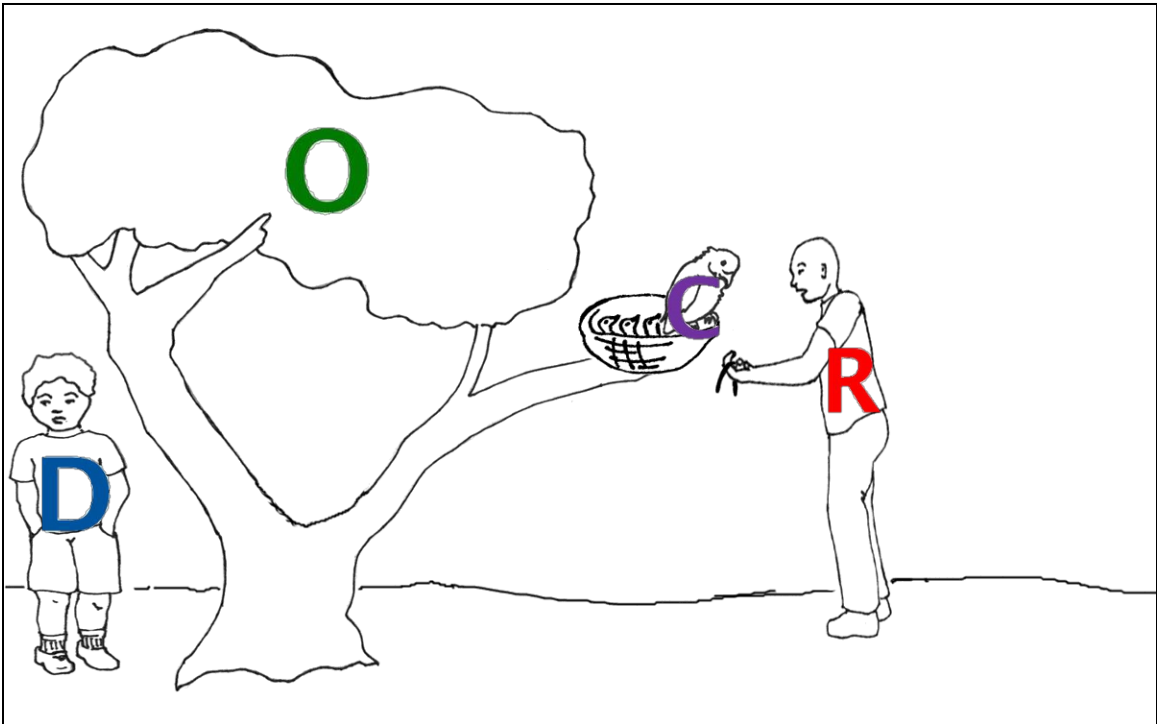
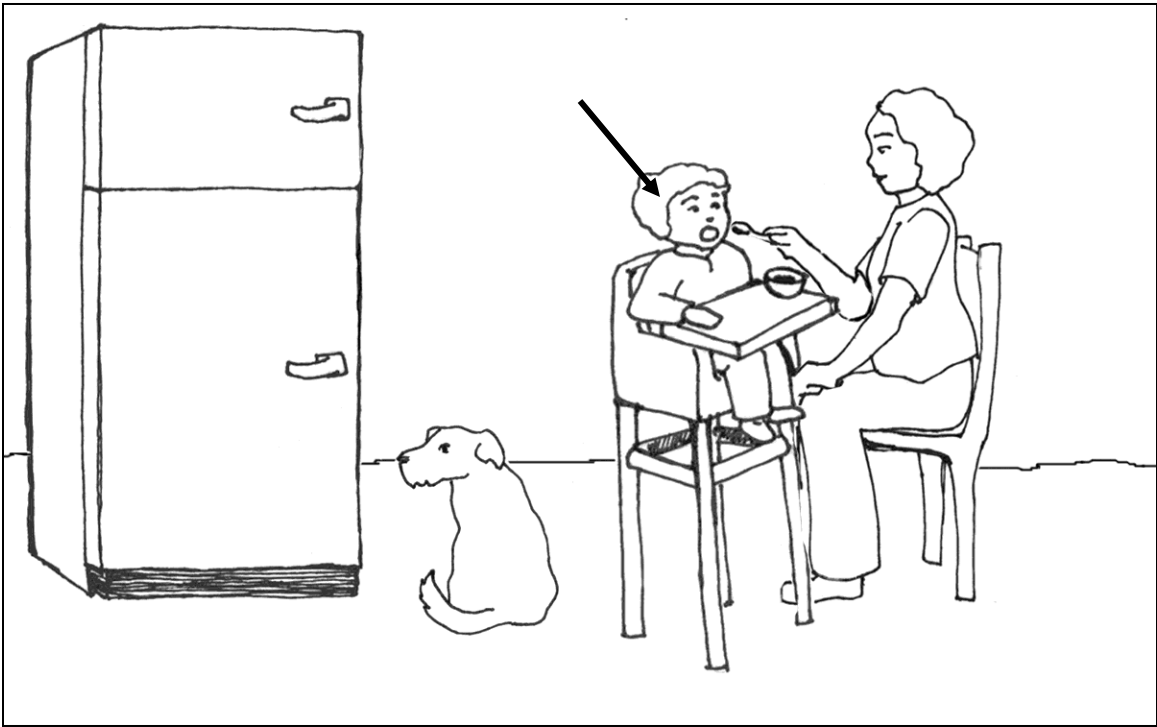

Problem 9-1a



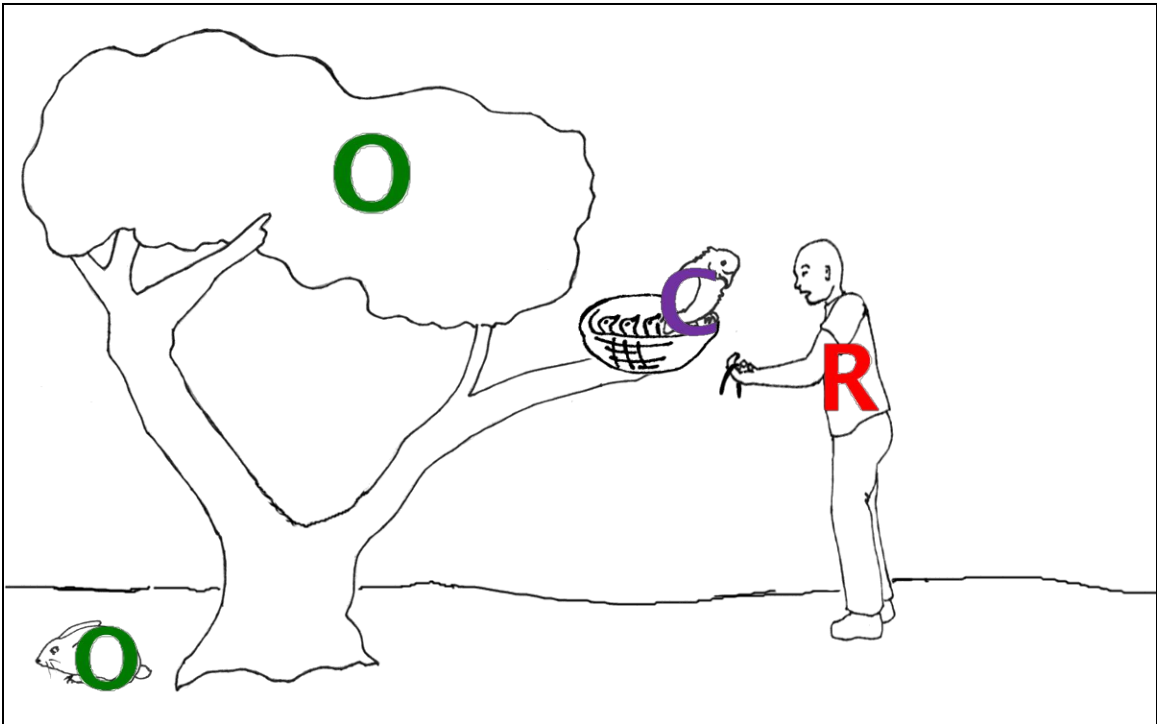
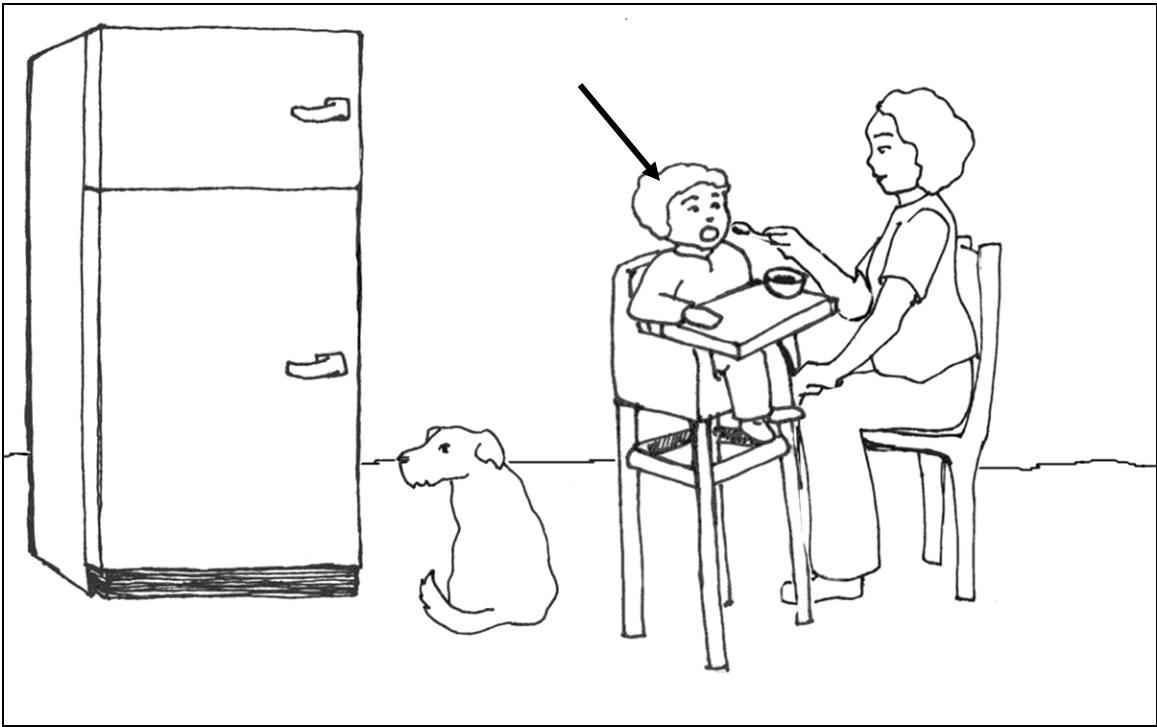

Problem 9-1 b

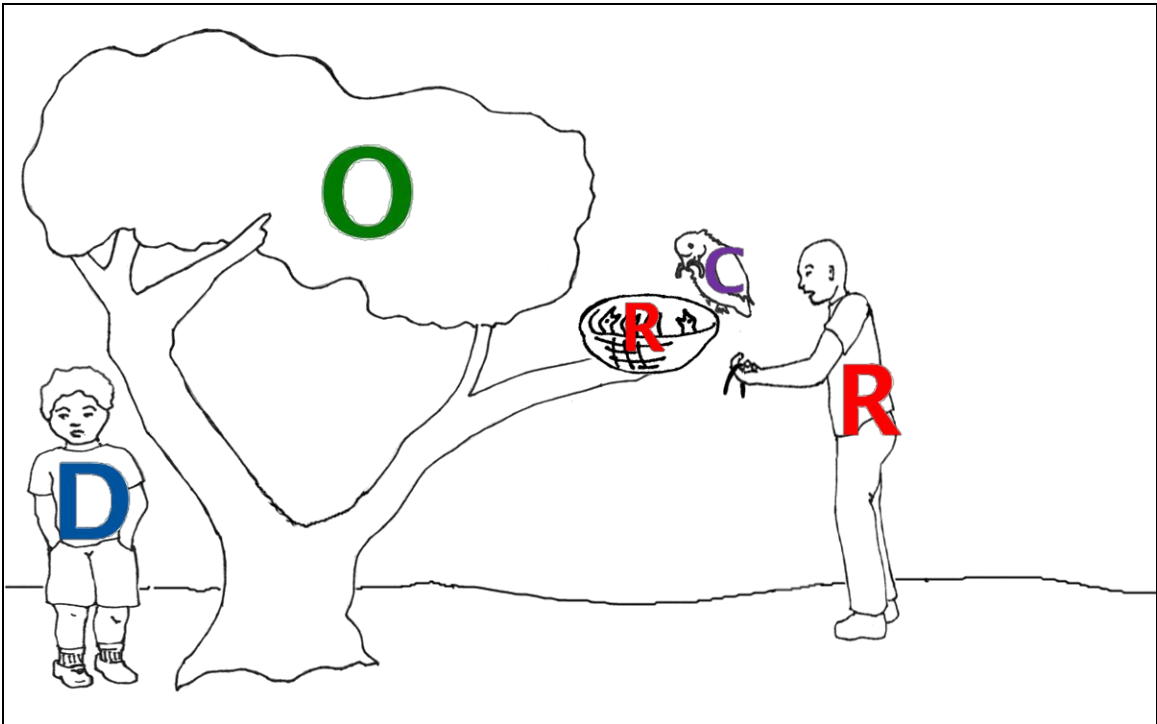
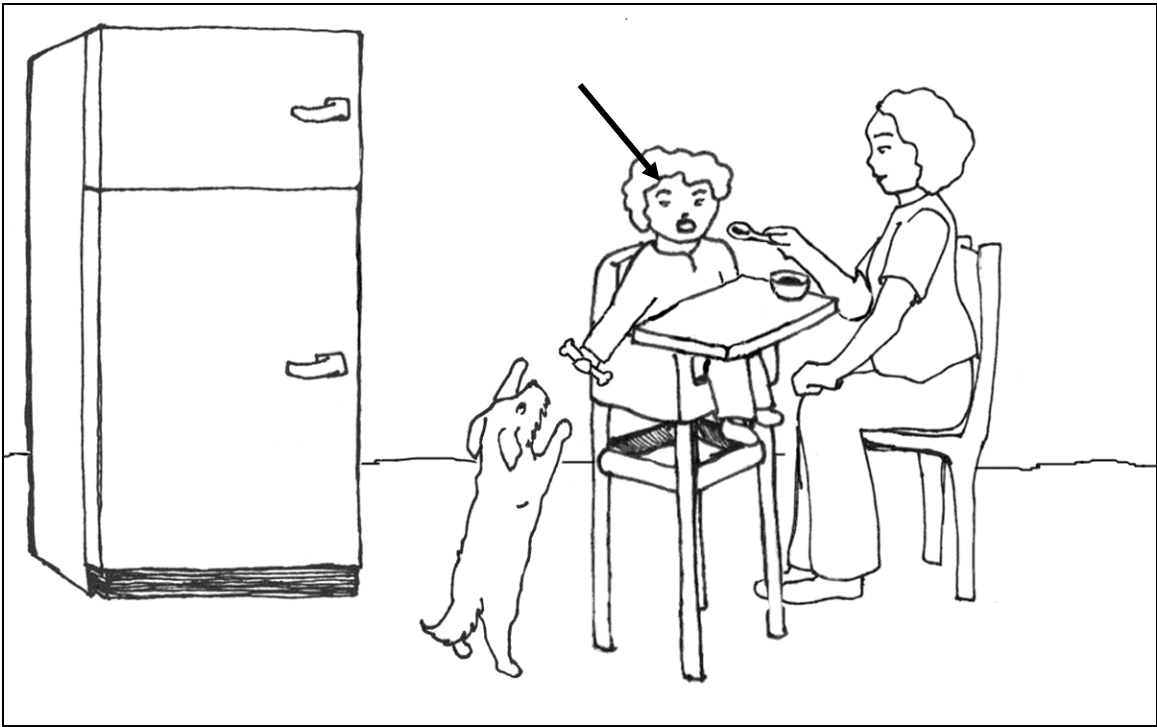

Problem 9-2a

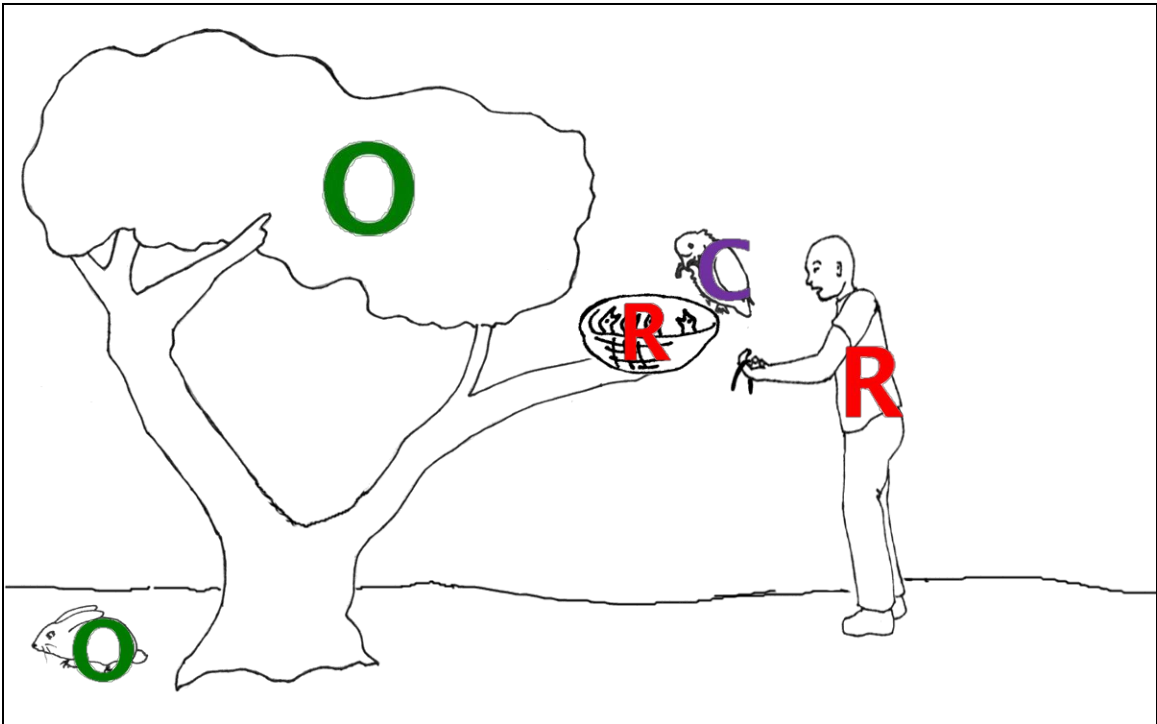
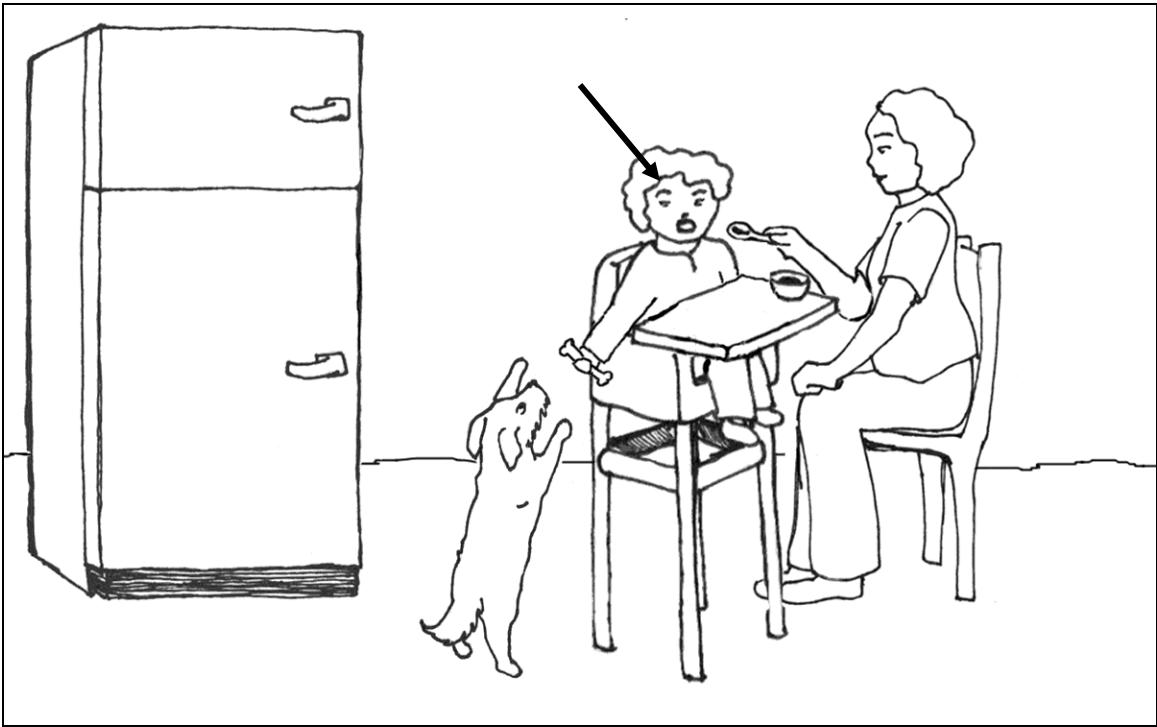

Problem 9-2b

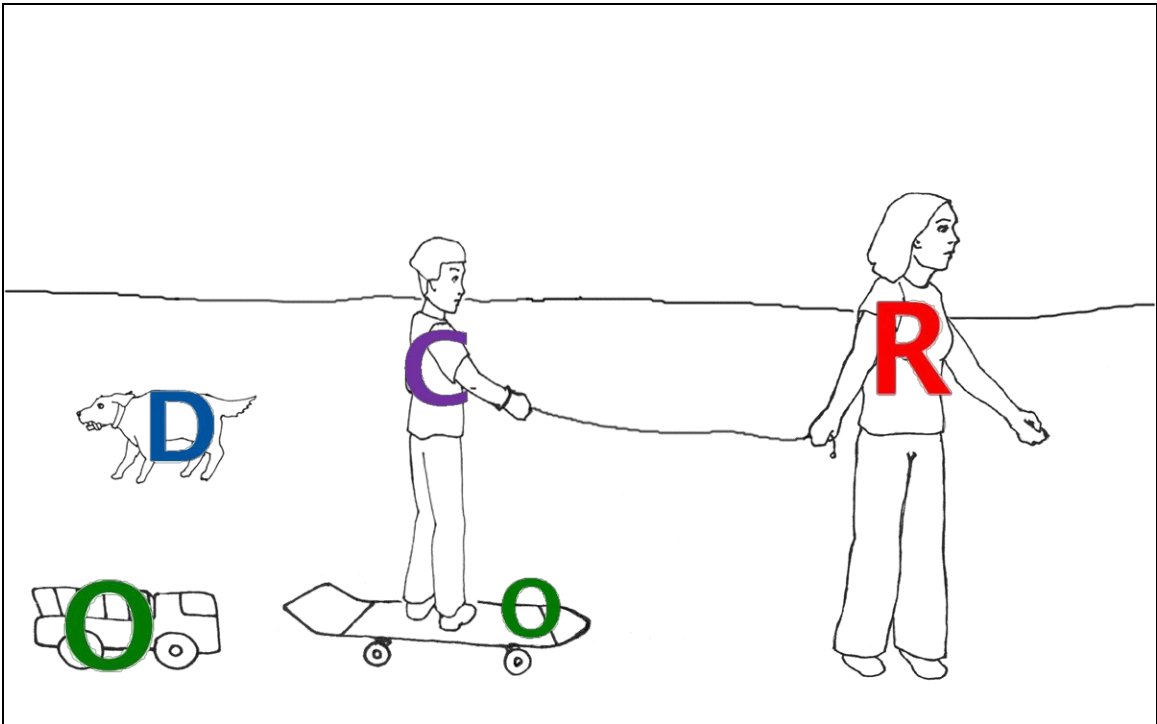
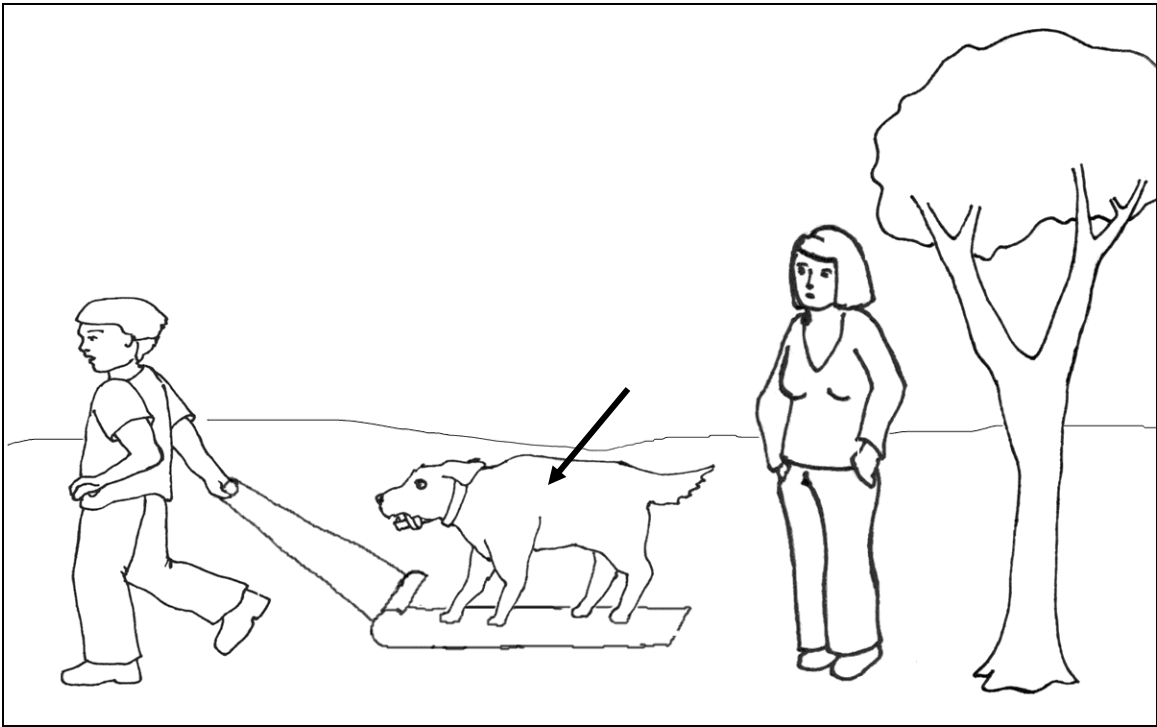

Problem 10-1a

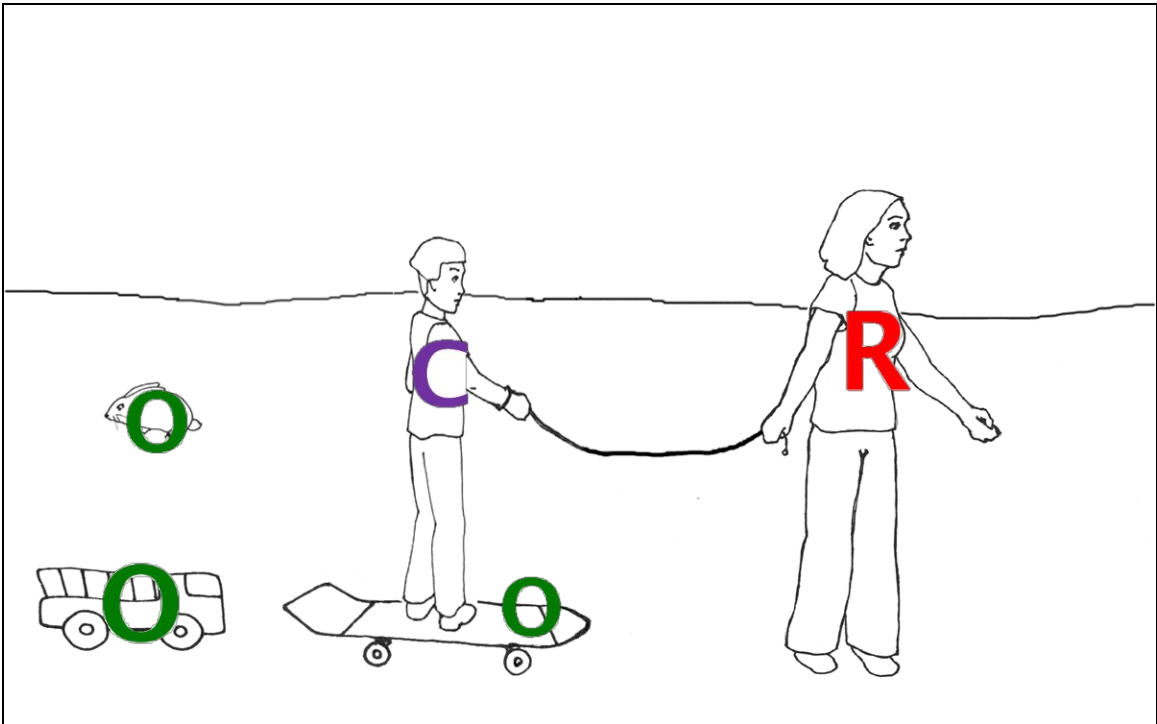
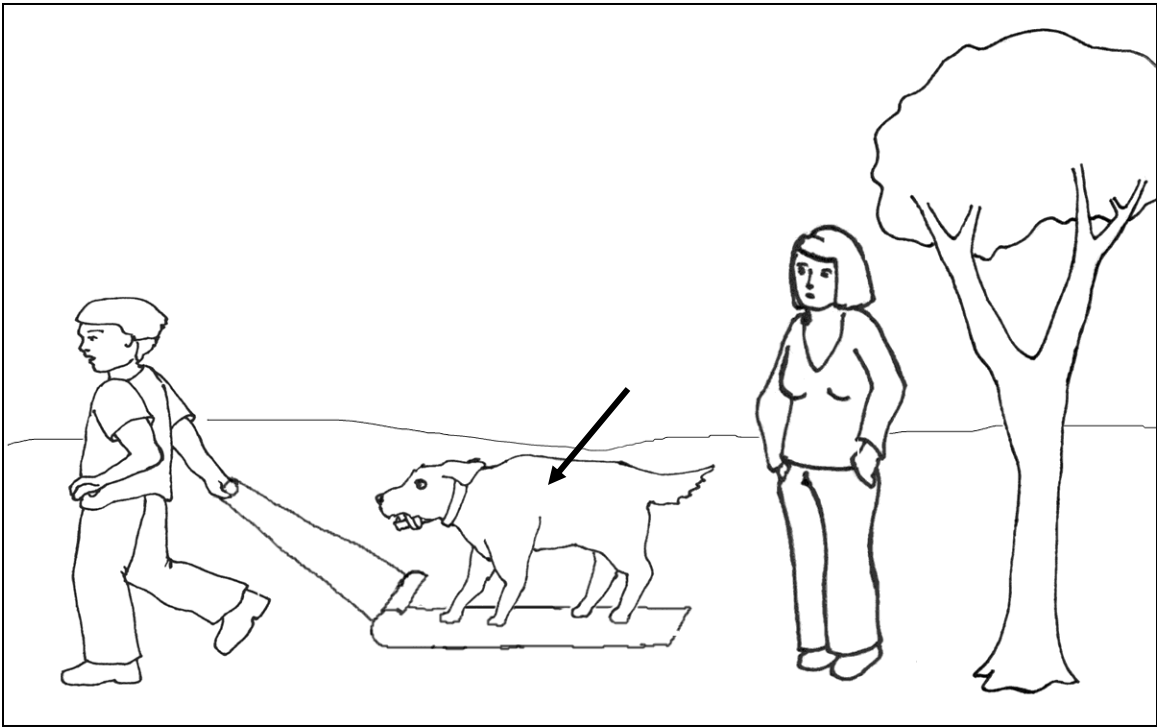

Problem 10-1b

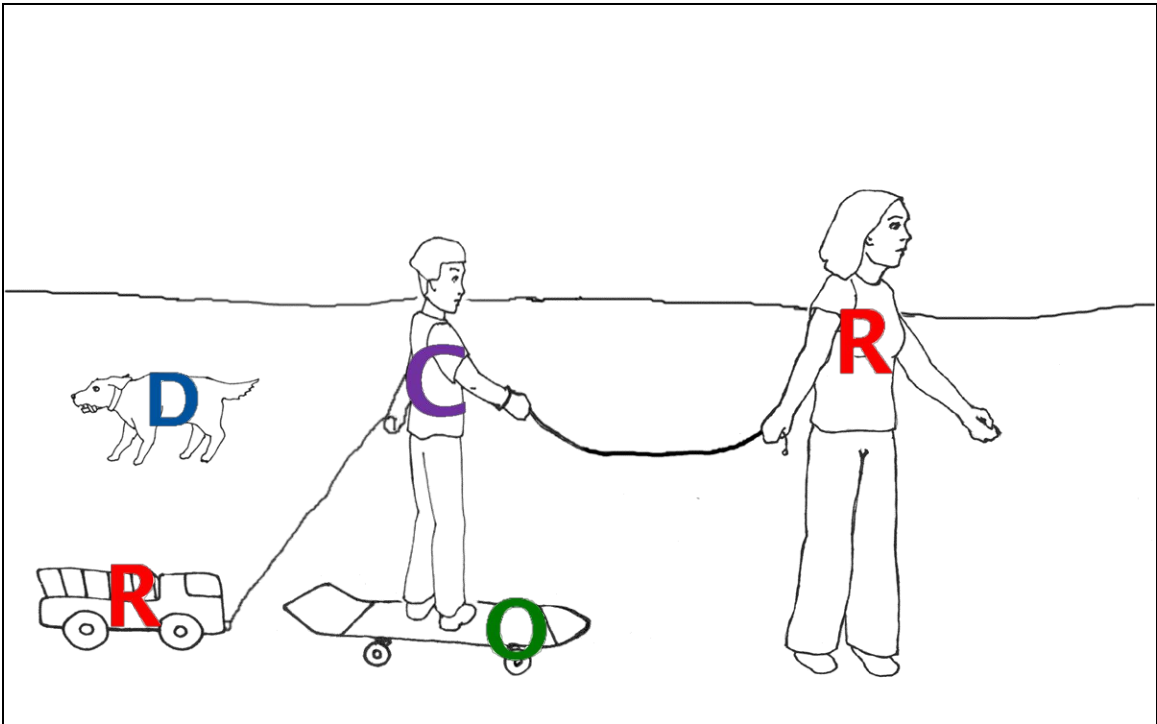
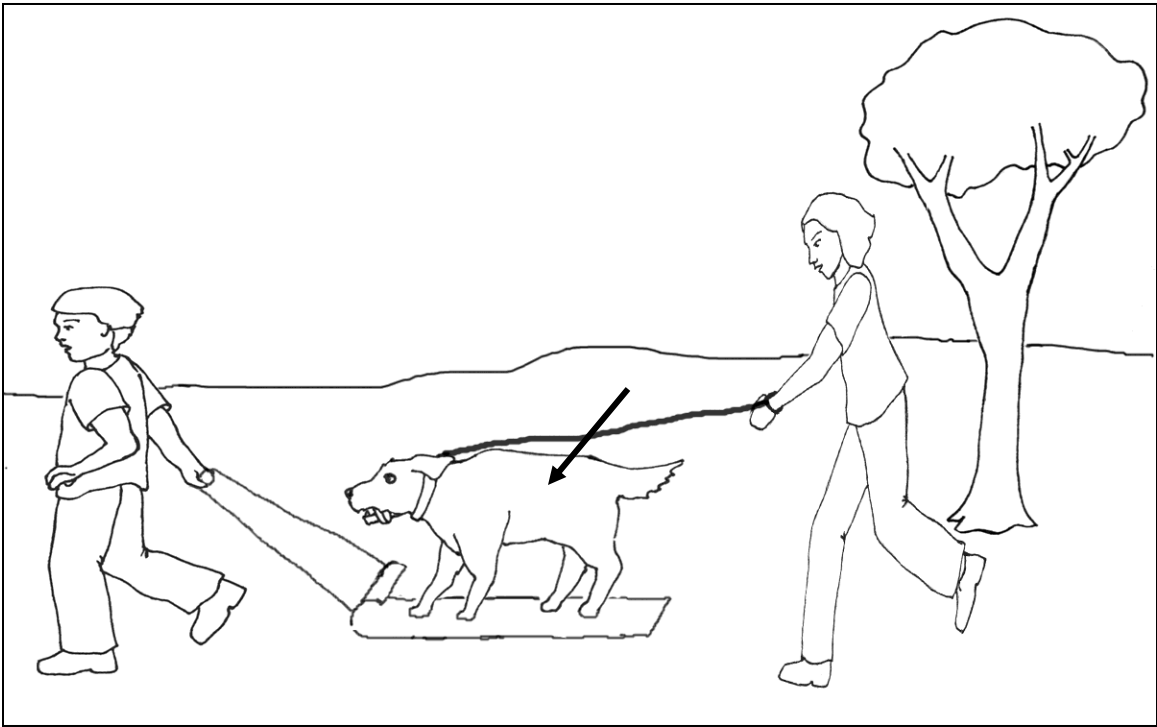

Problem 10-  
2a

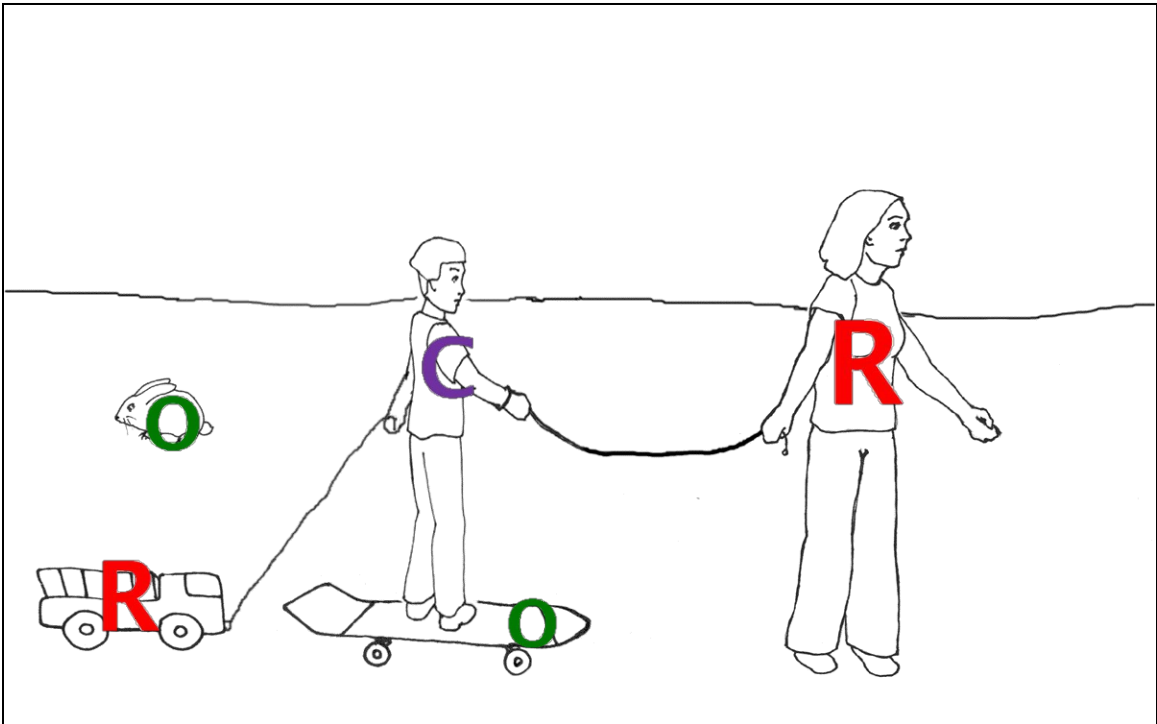
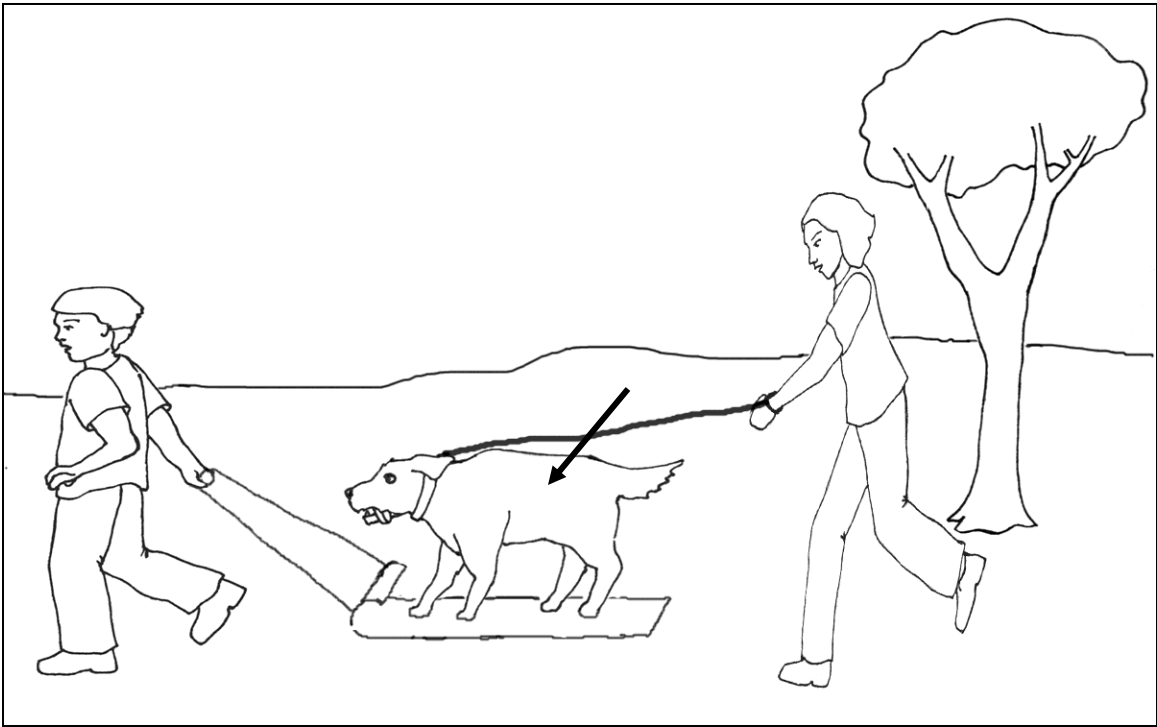

Problem 10-  
2b

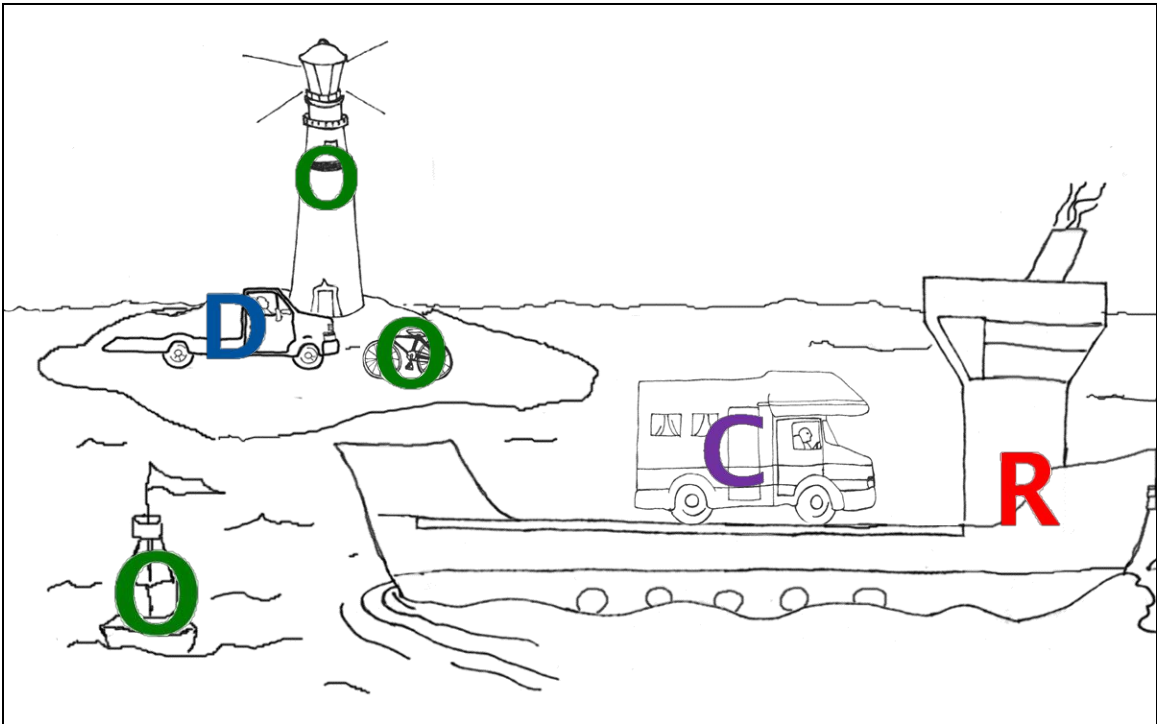
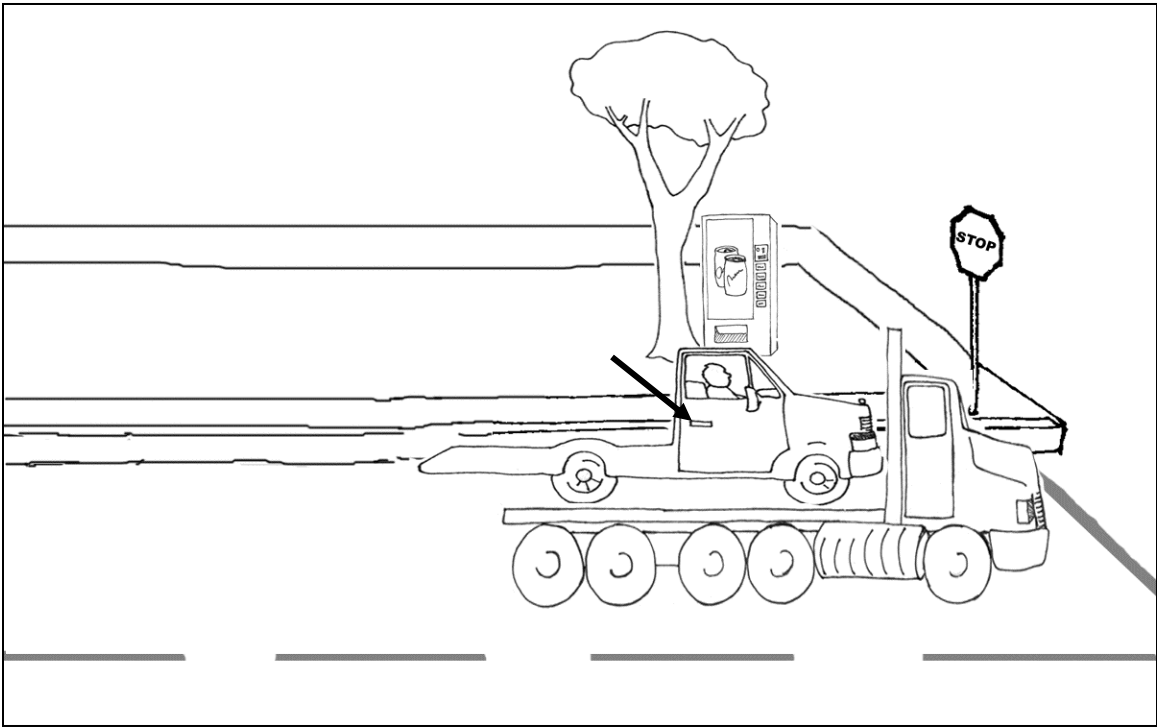

Problem 11-  
1a



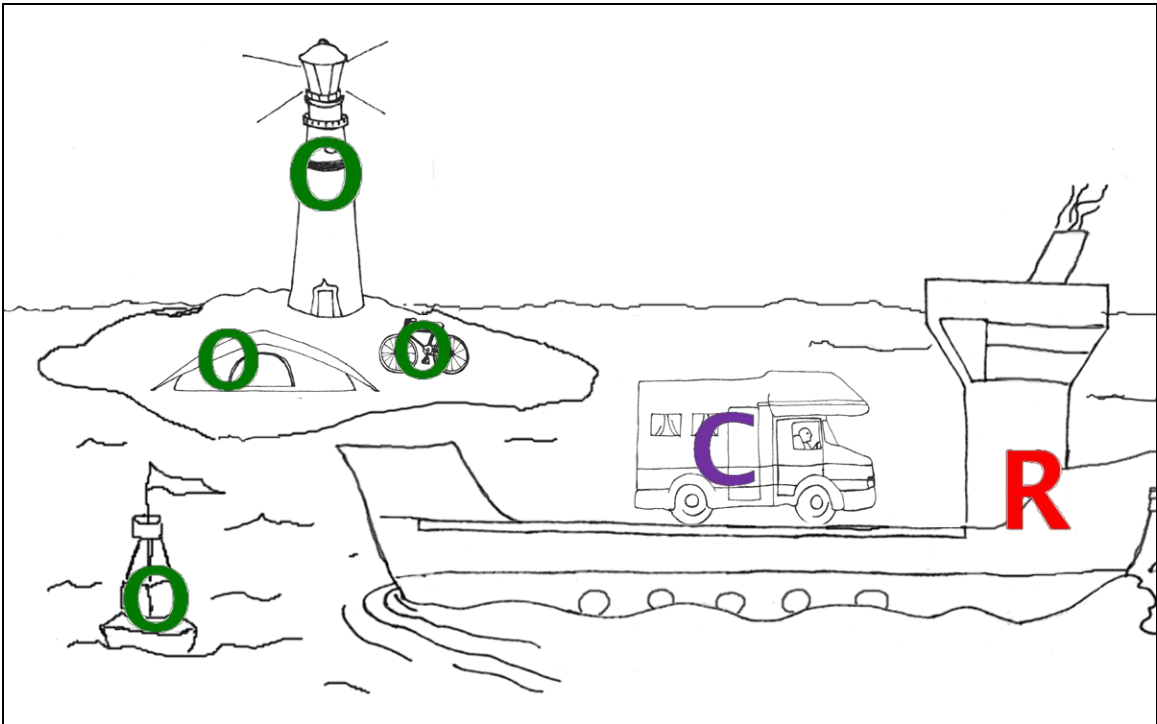
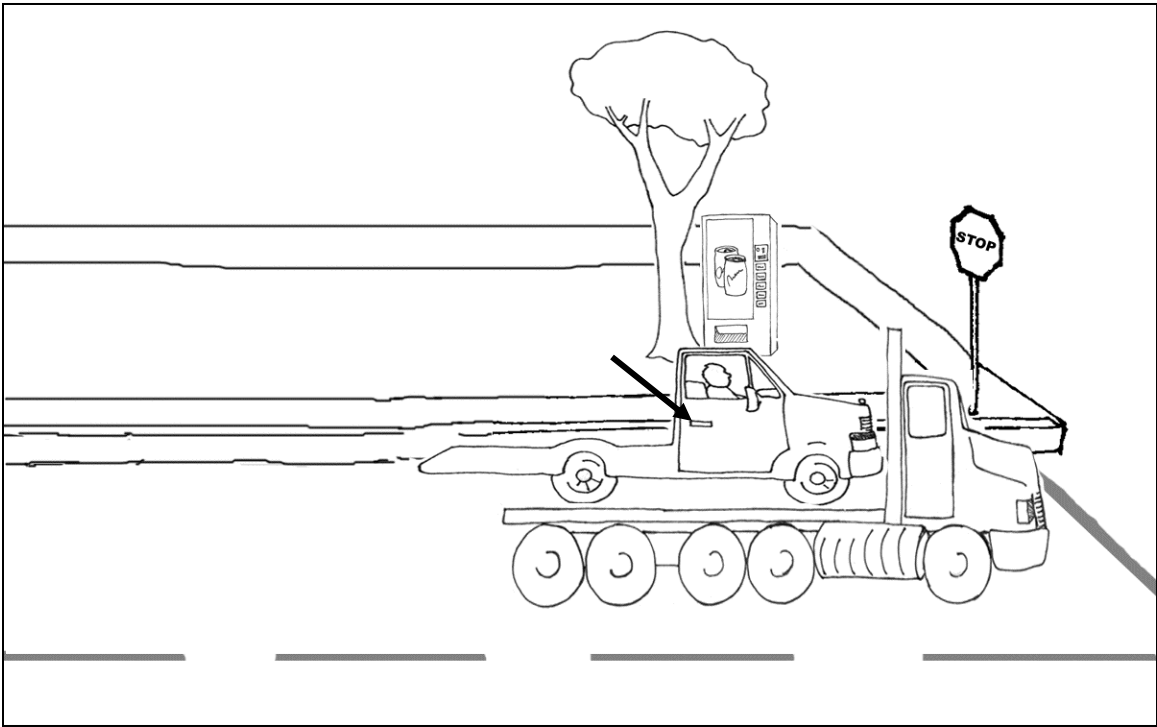

Problem 11-  
1b

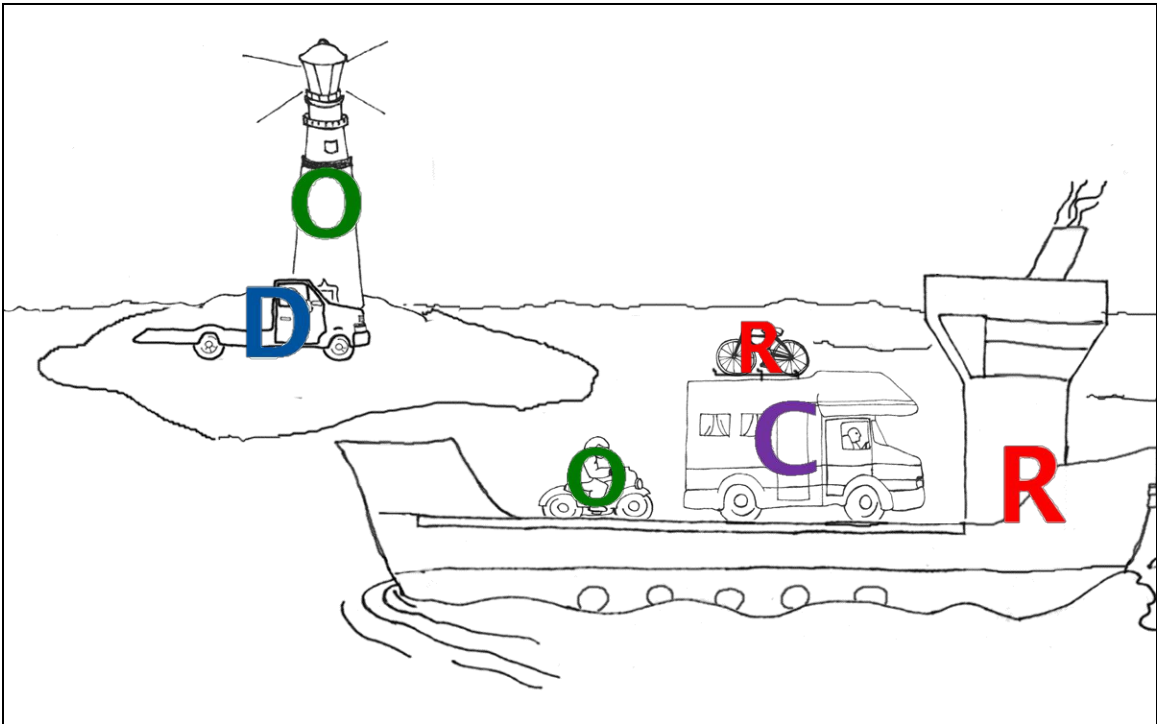
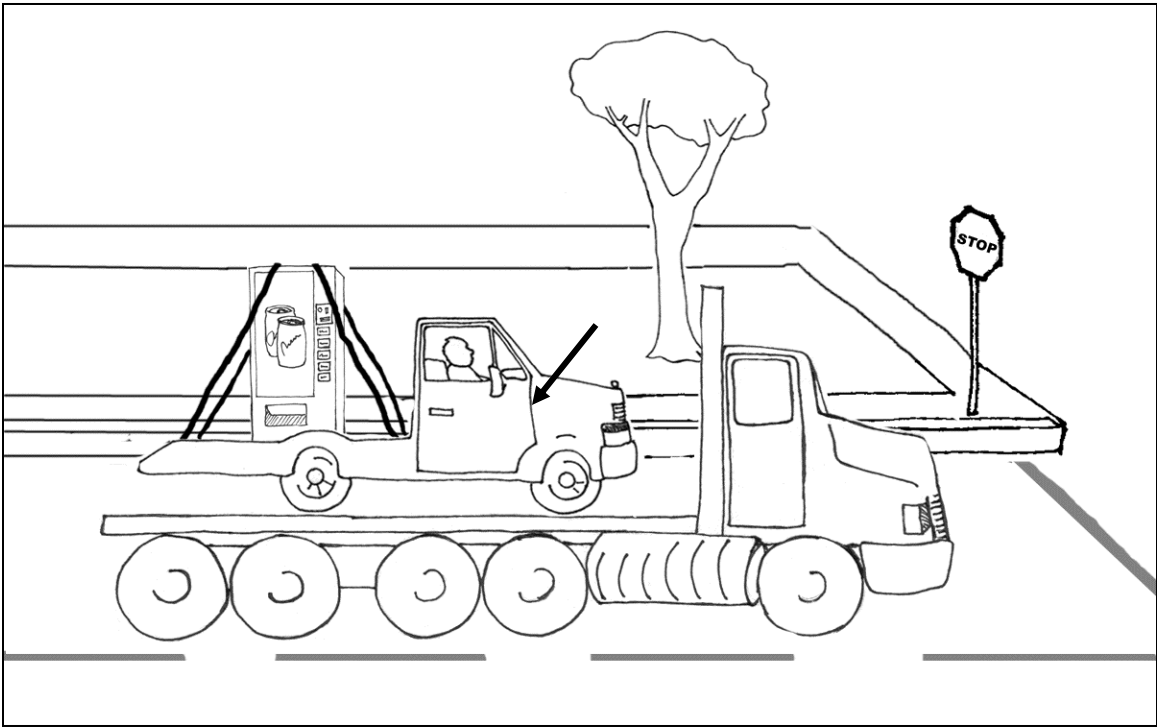

Problem 11-  
2a

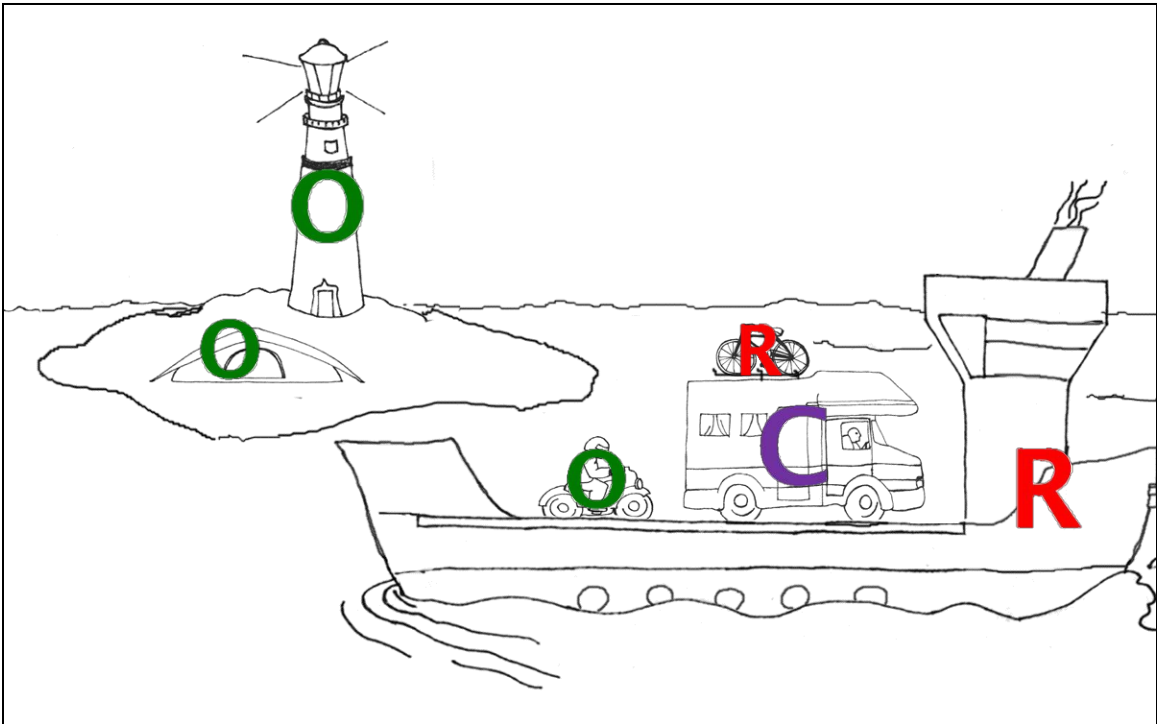
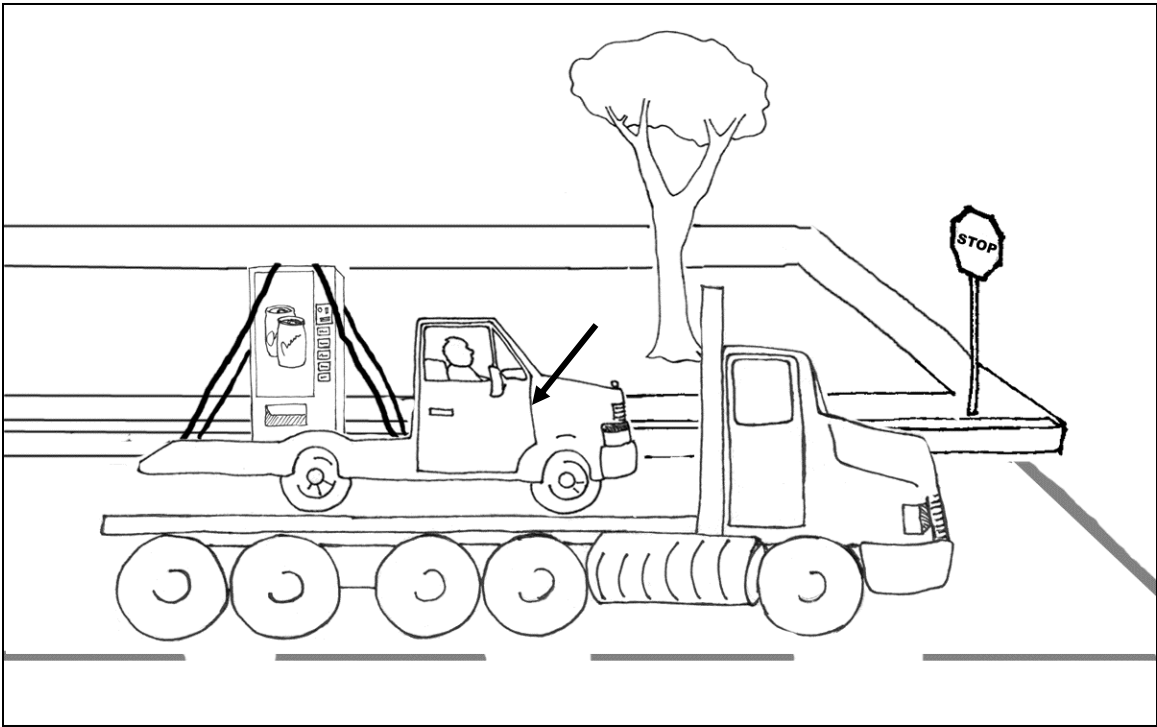

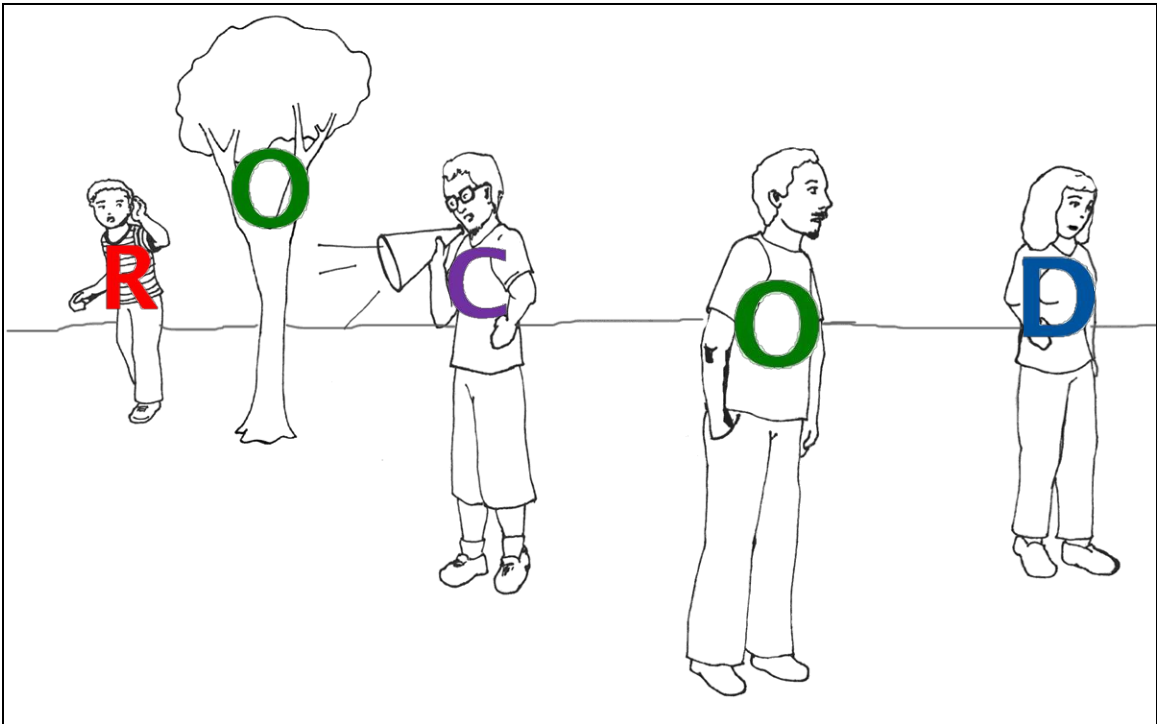

Problem 12-1a

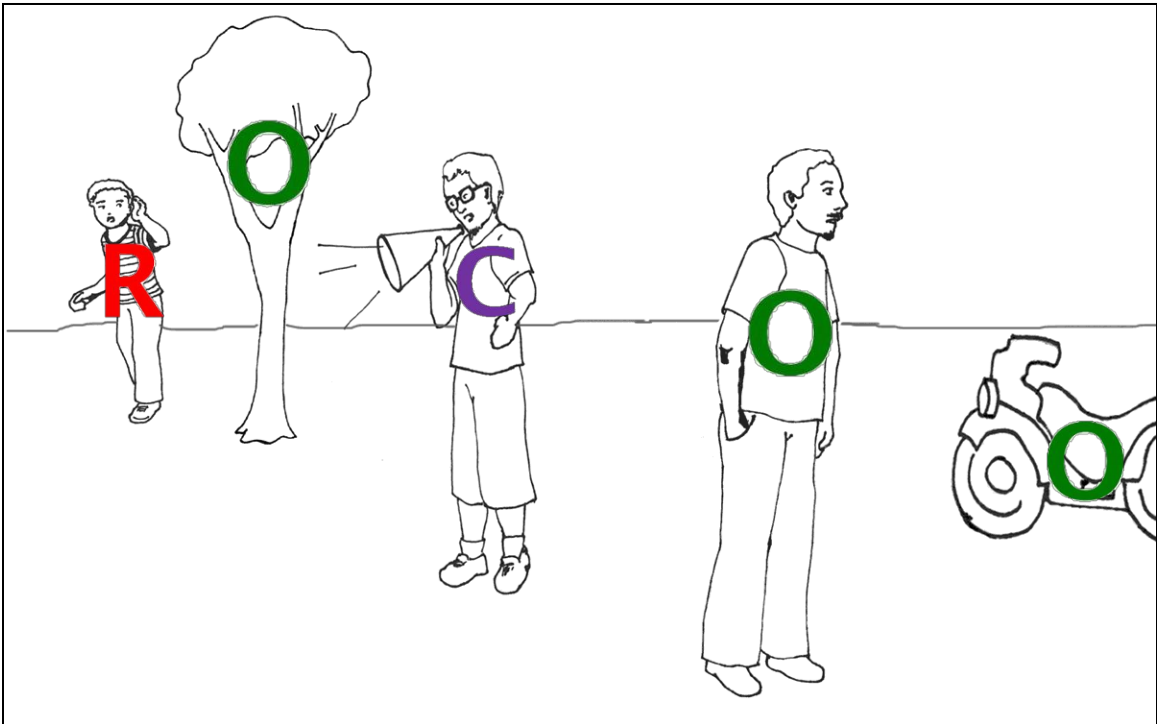

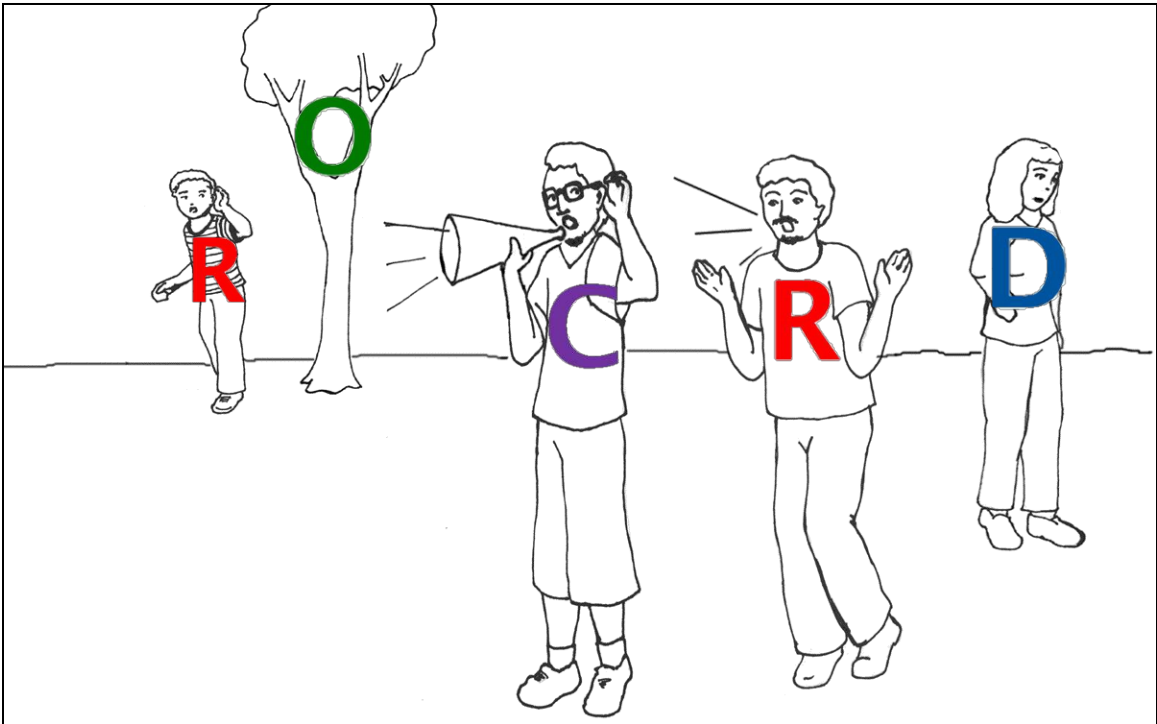

Problem 12-2a

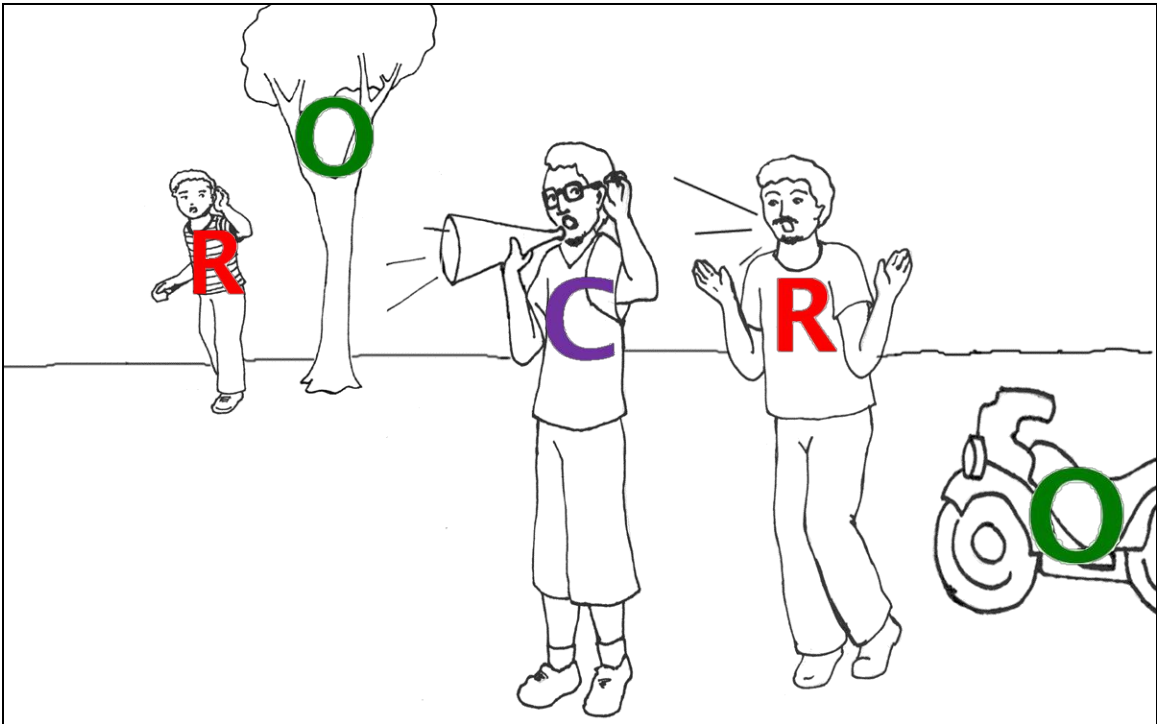

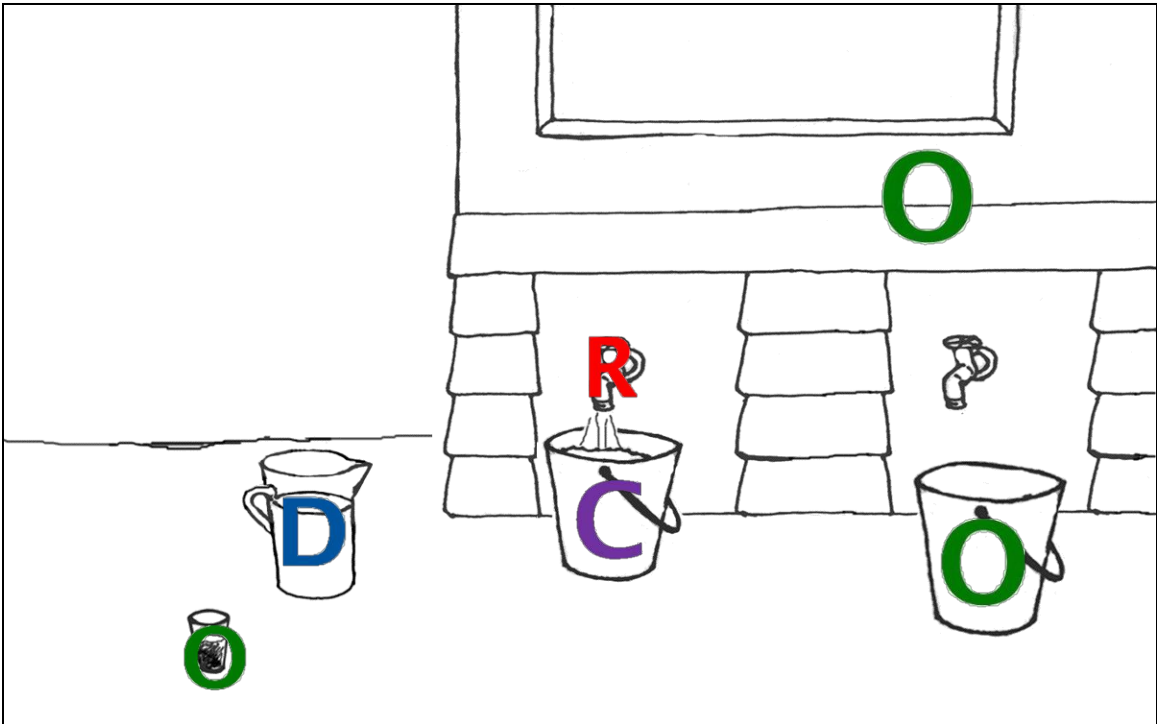
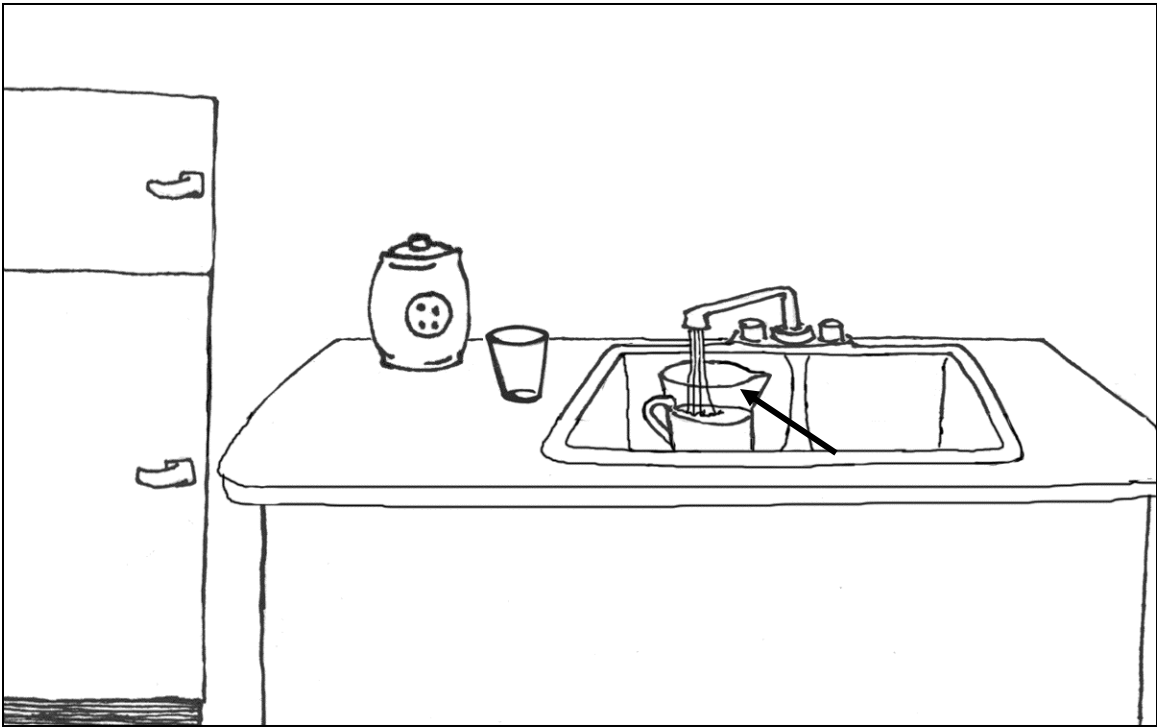

Problem 13-  
1a



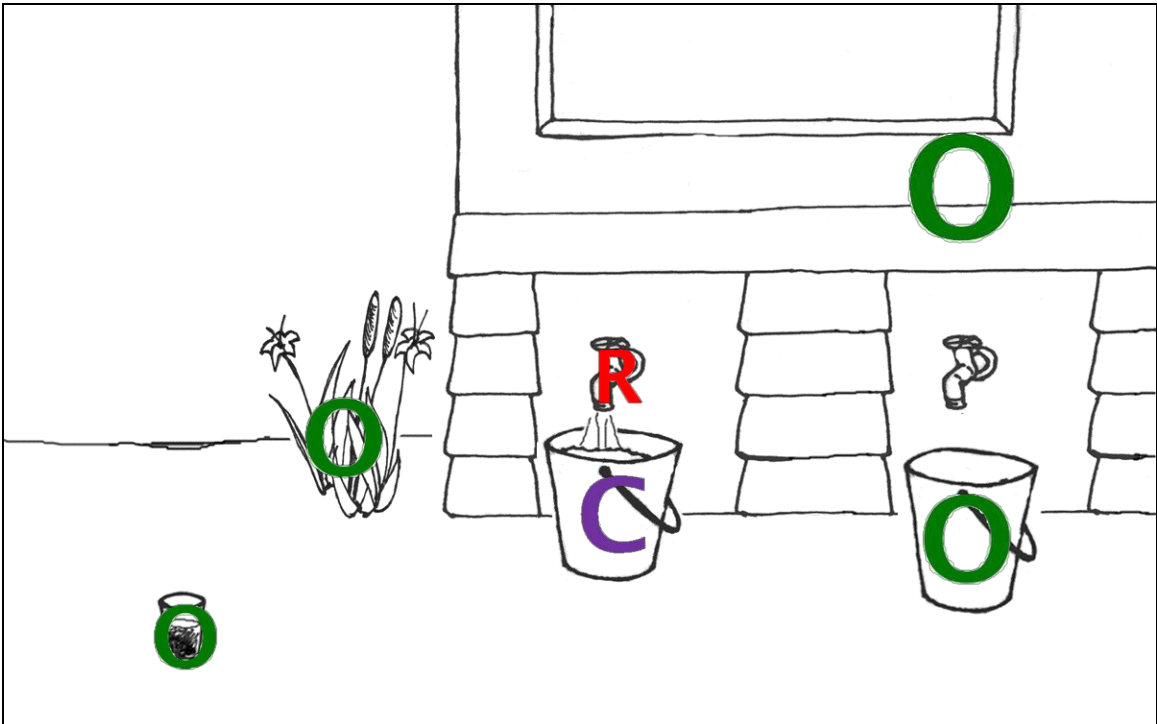
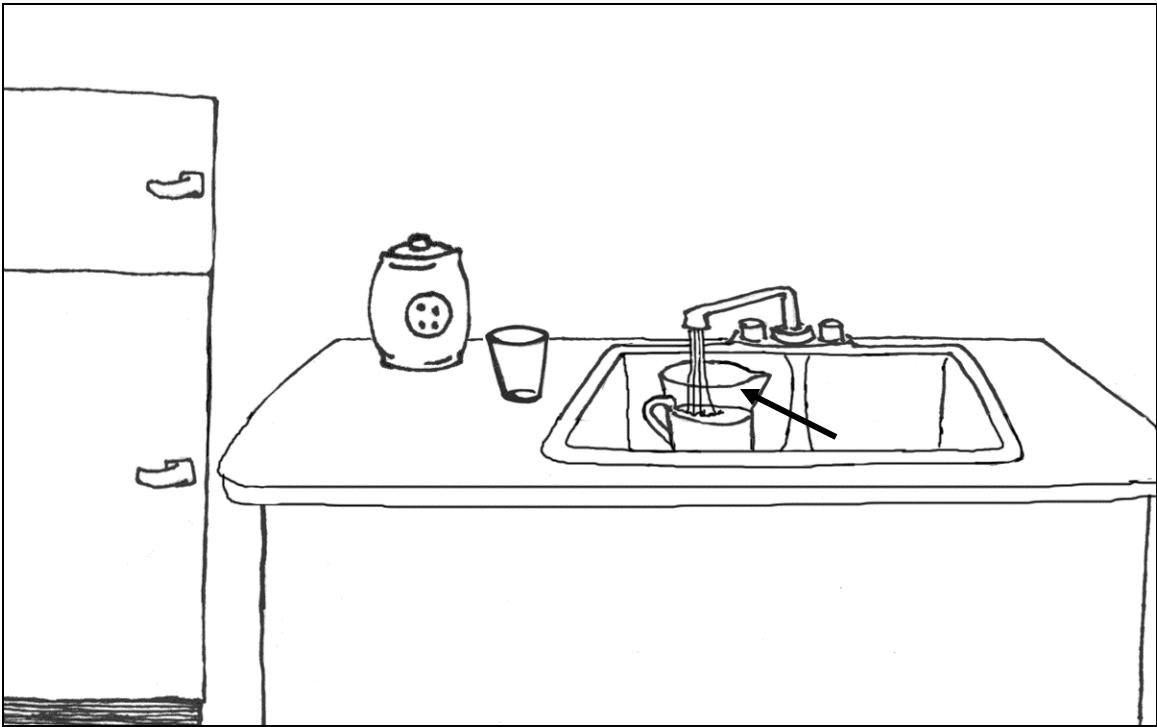

Problem 13-  
1b

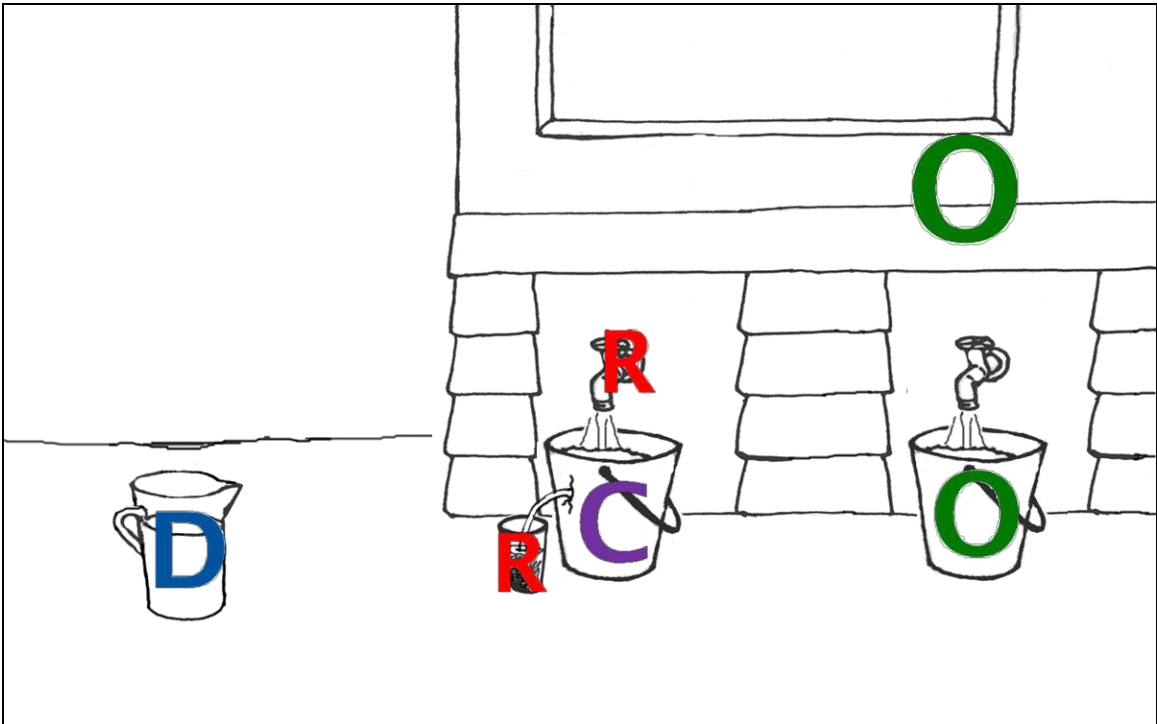
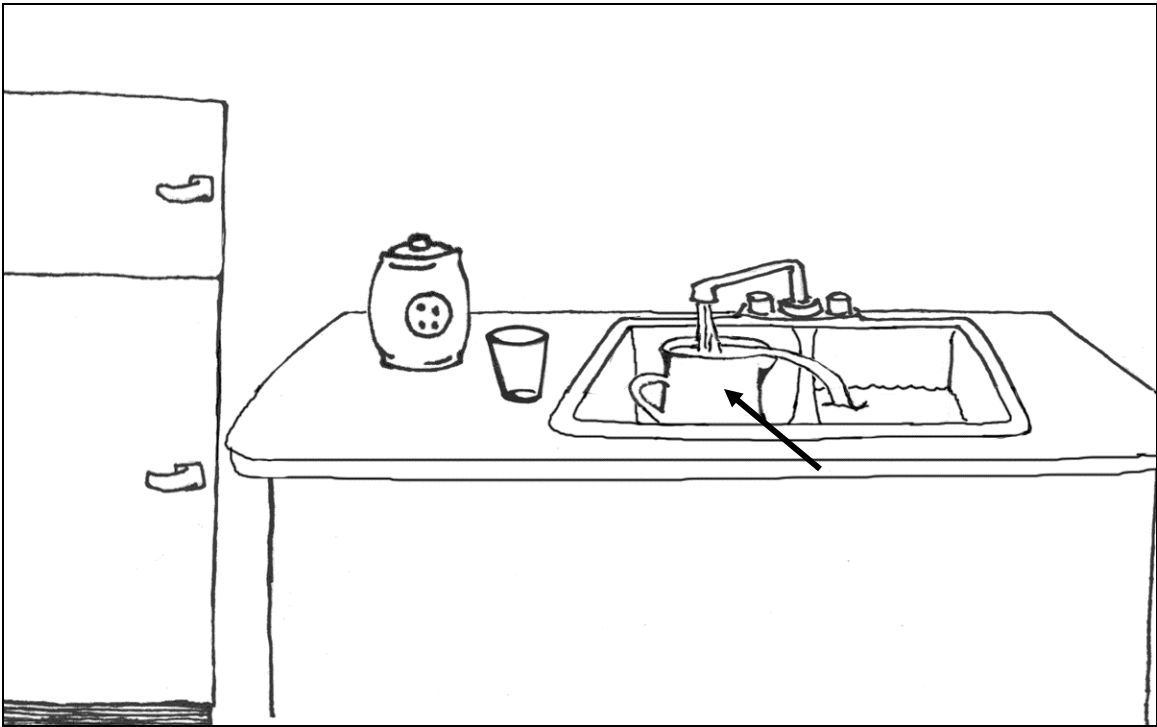

Problem 13-  
2a

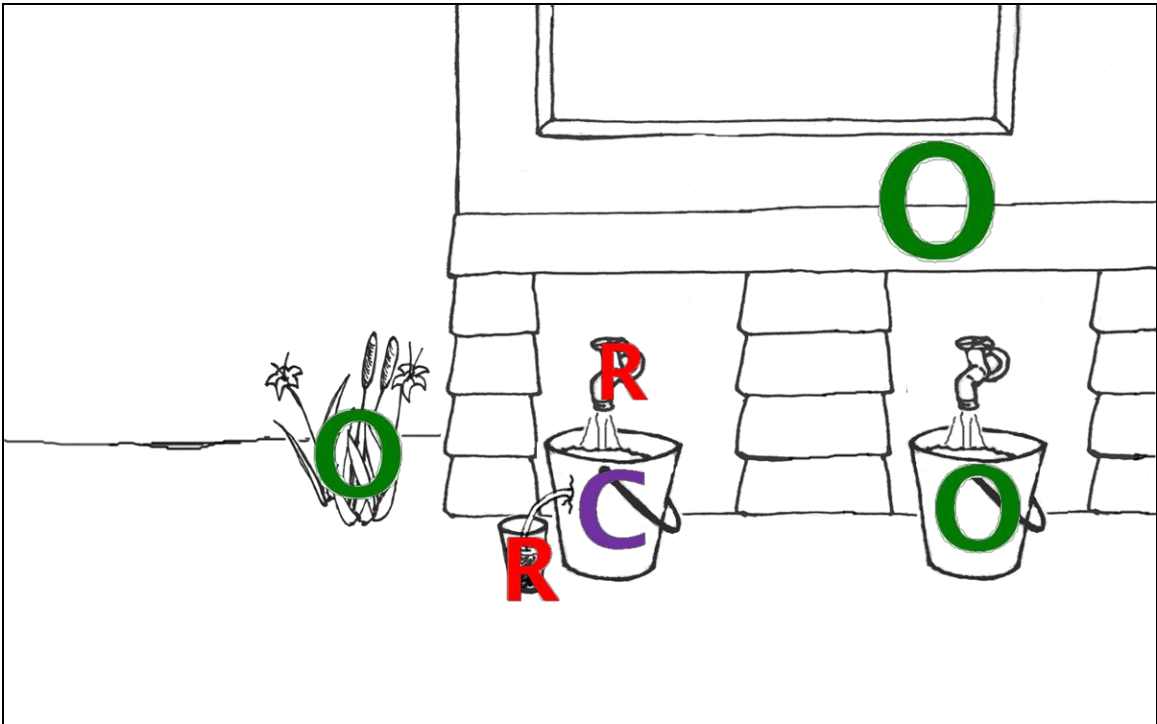
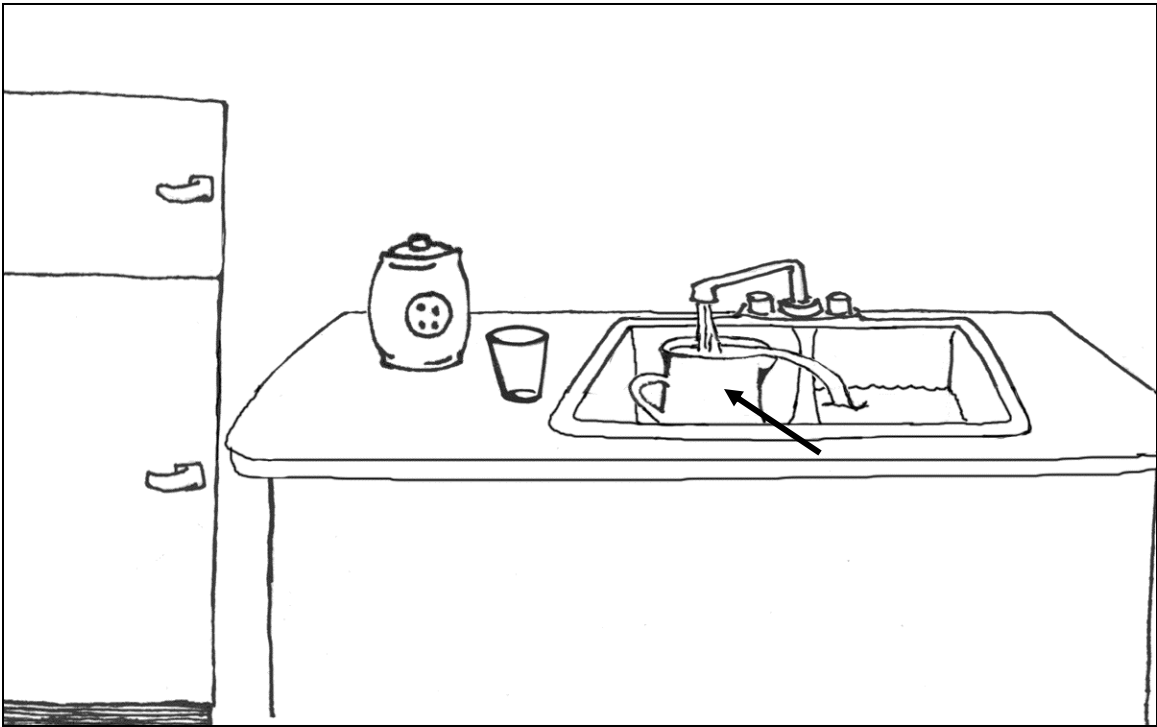

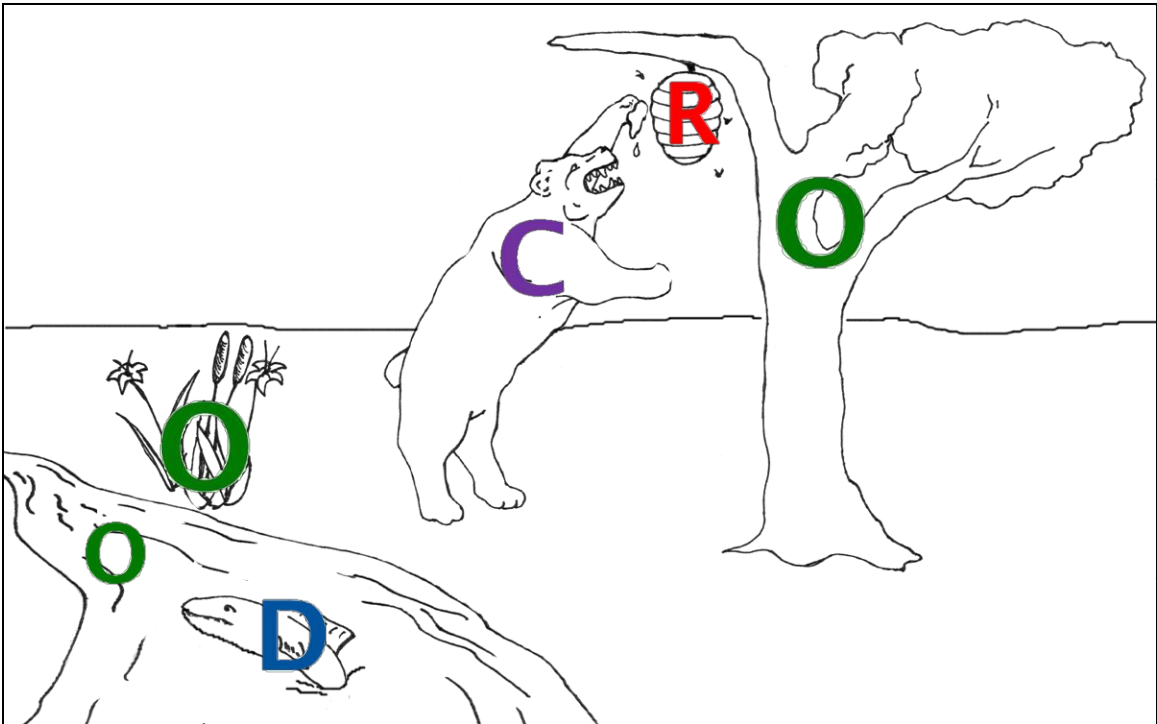
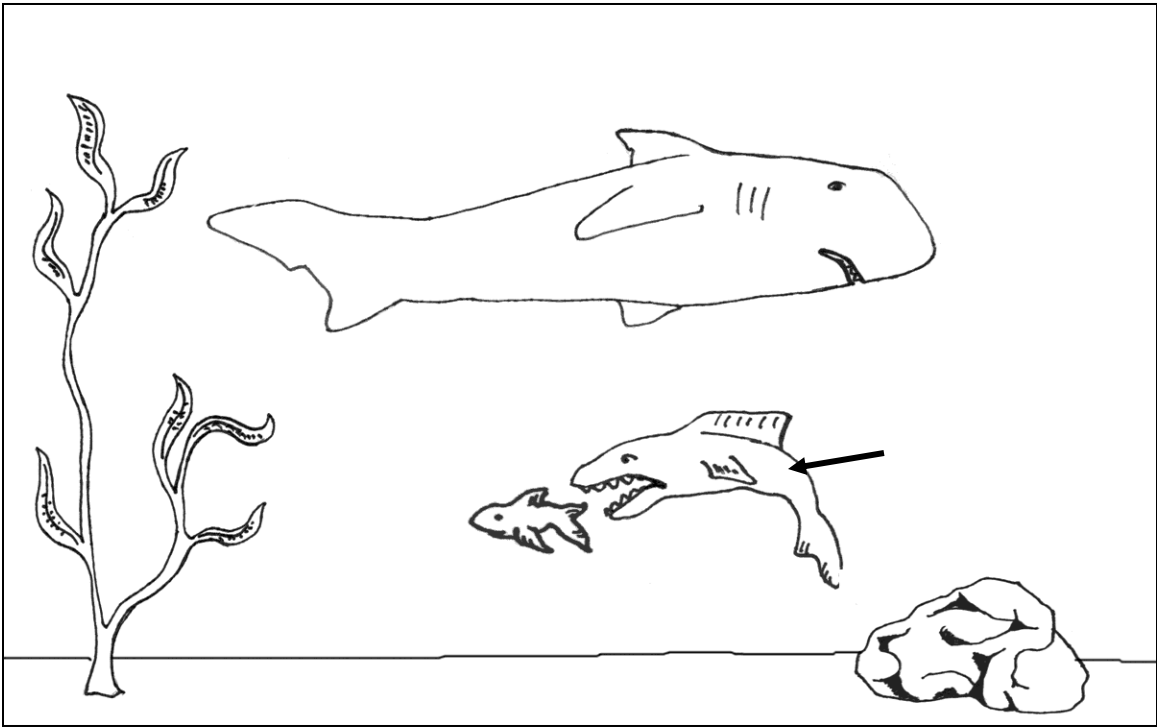

Problem 14-  
1a

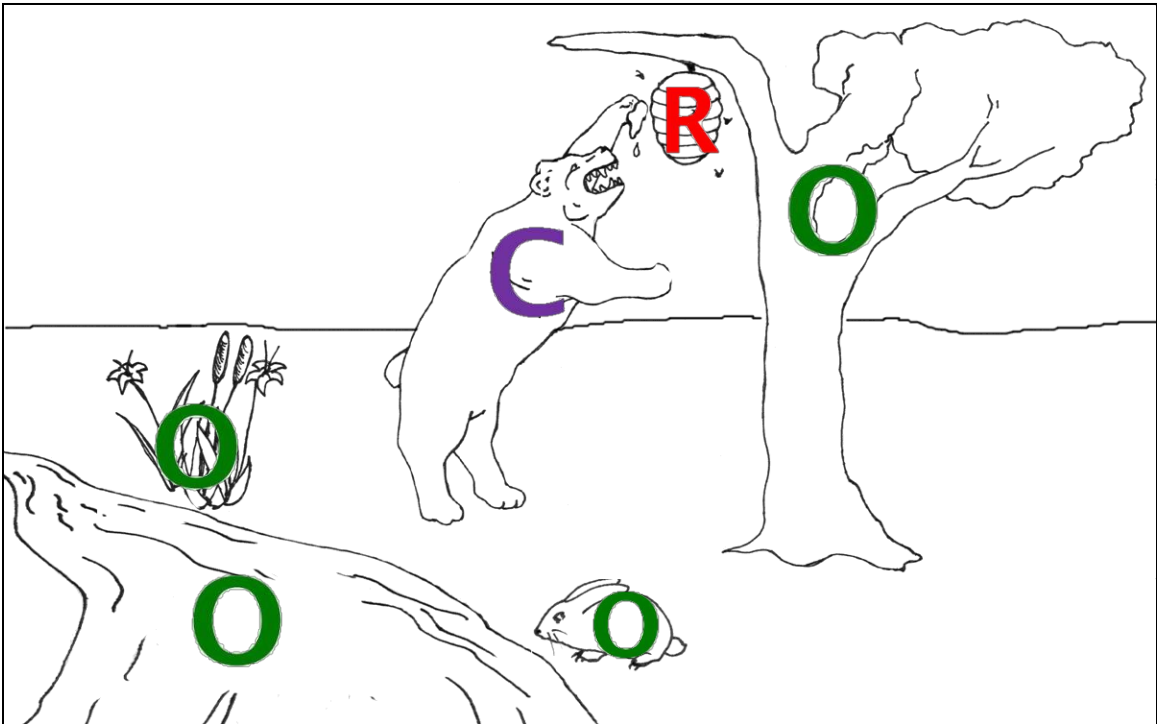
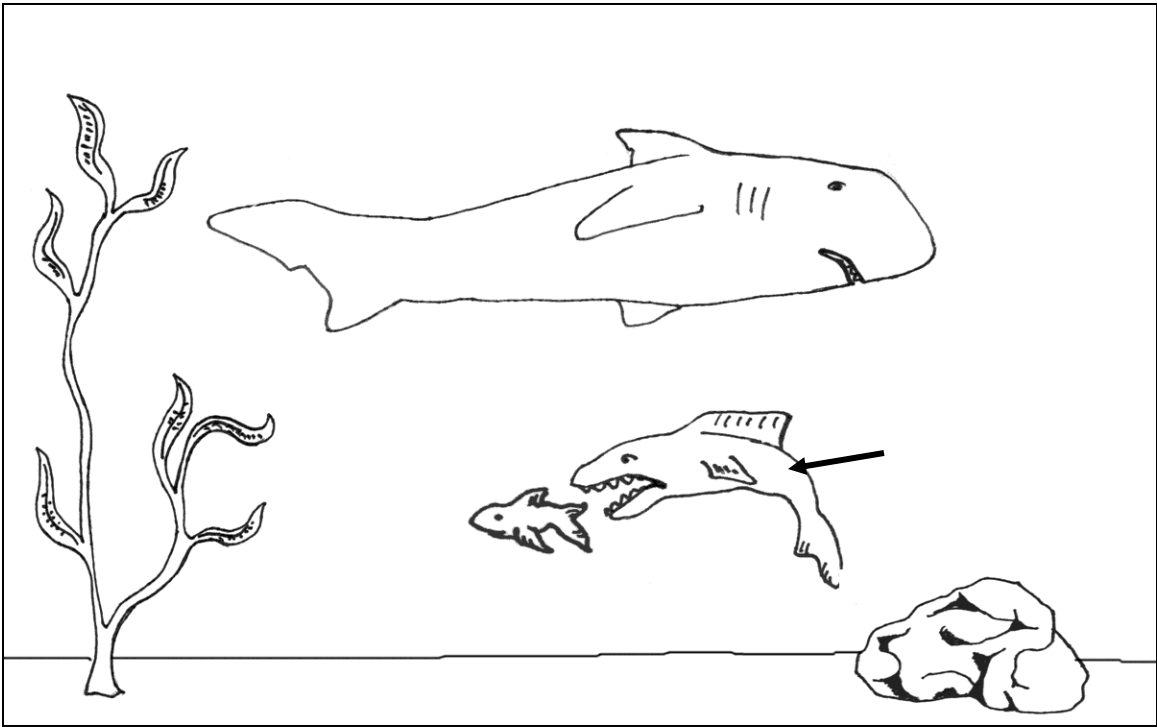

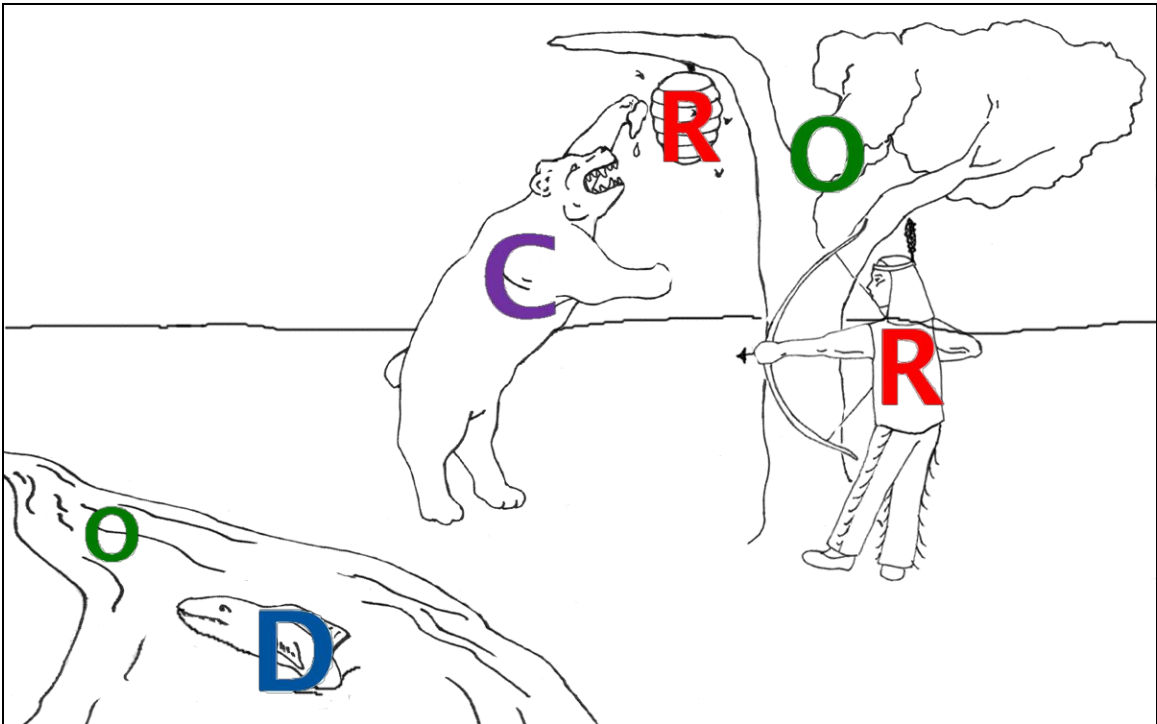

Problem 14-  
2a

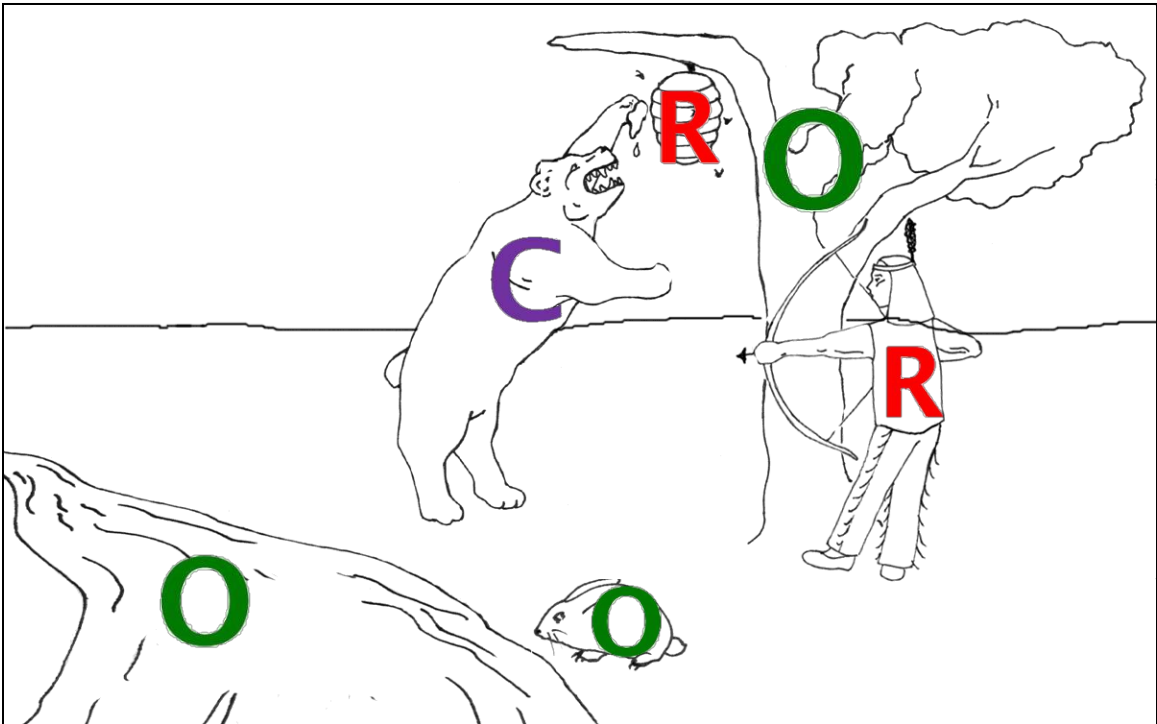

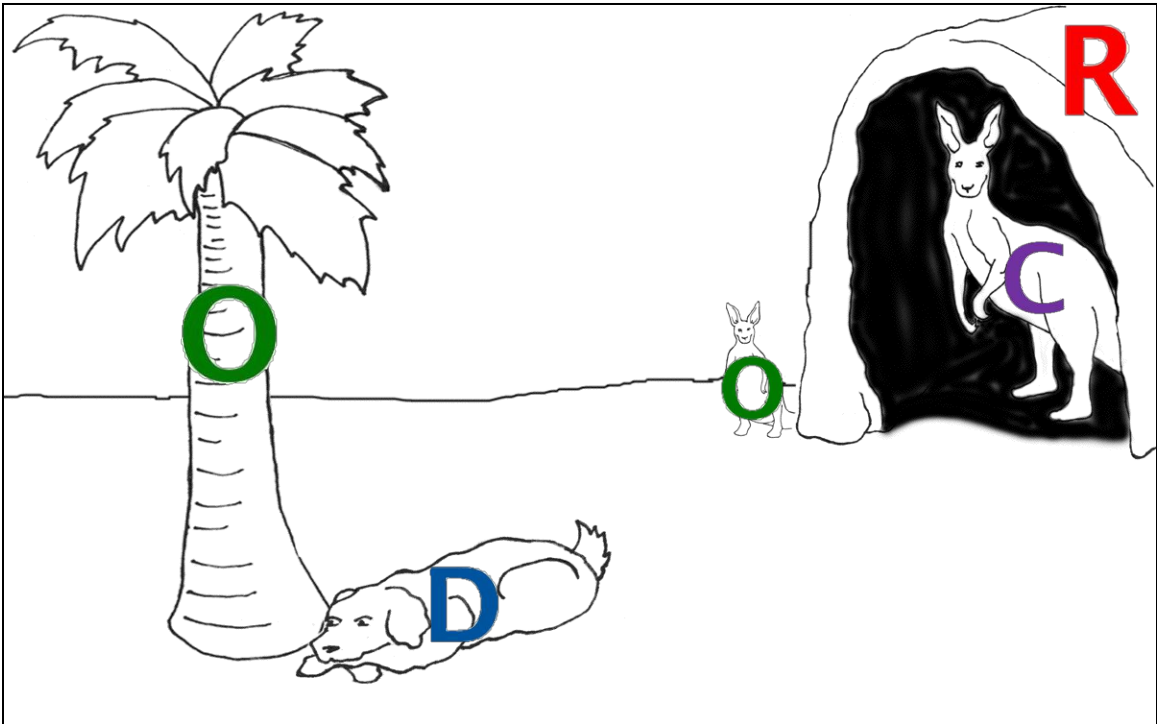
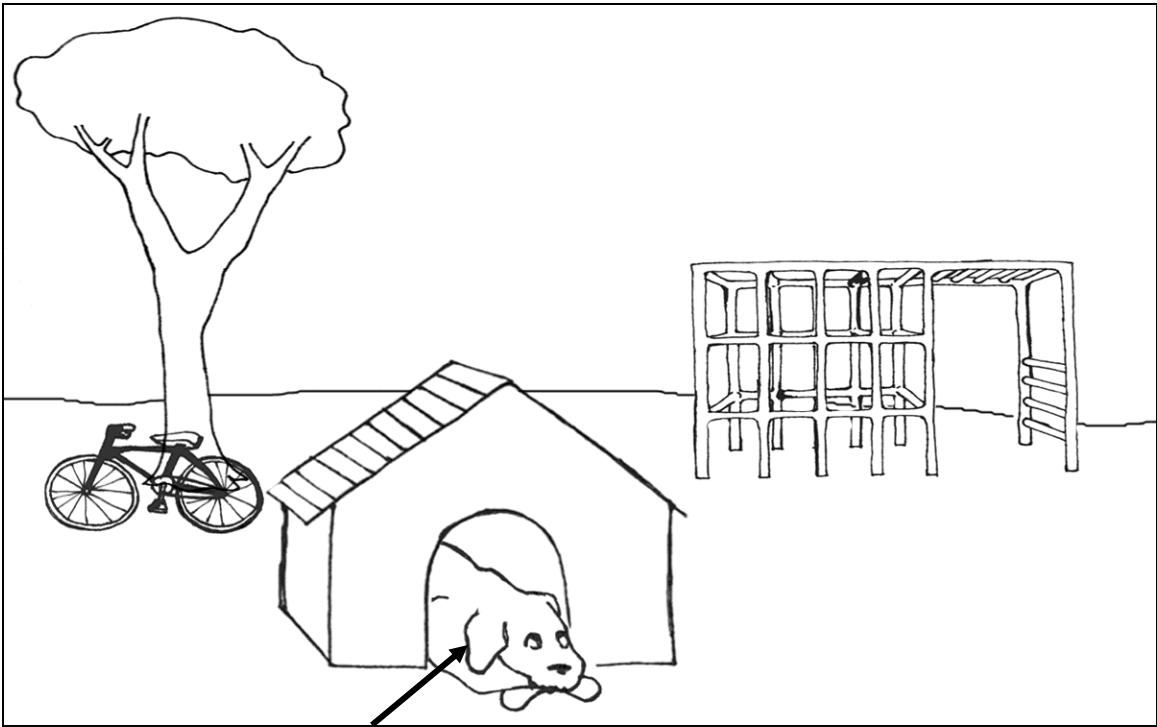

Problem 15-  
1a



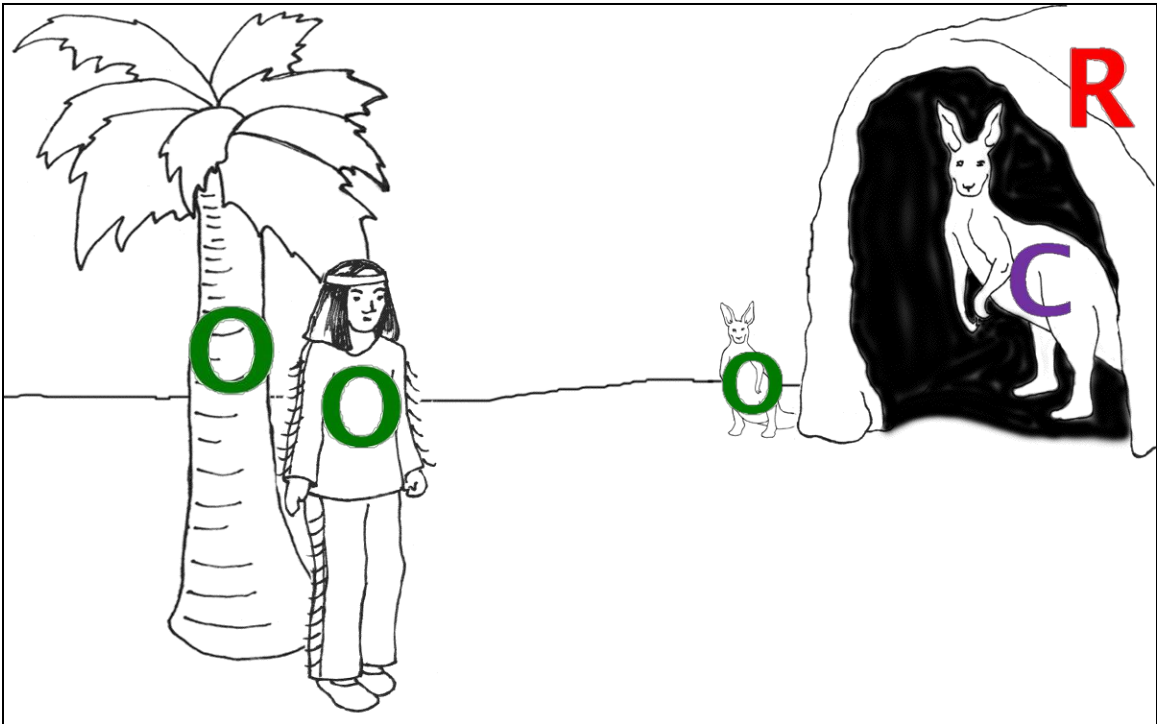
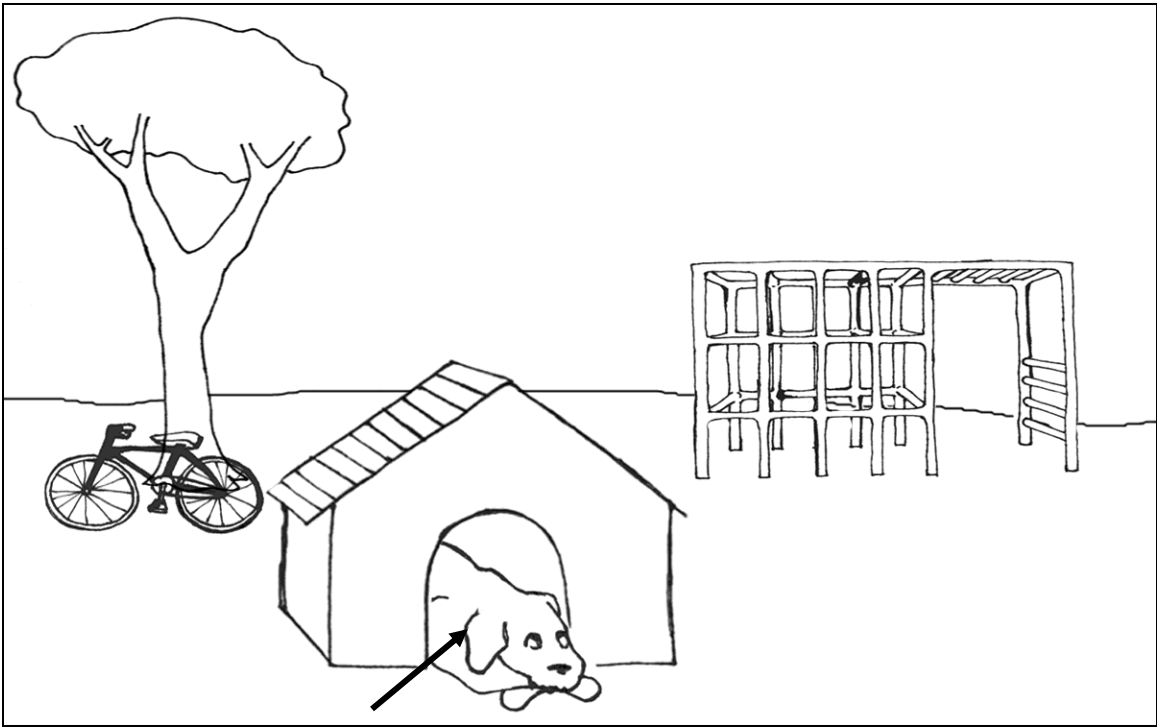

Problem 15-1b

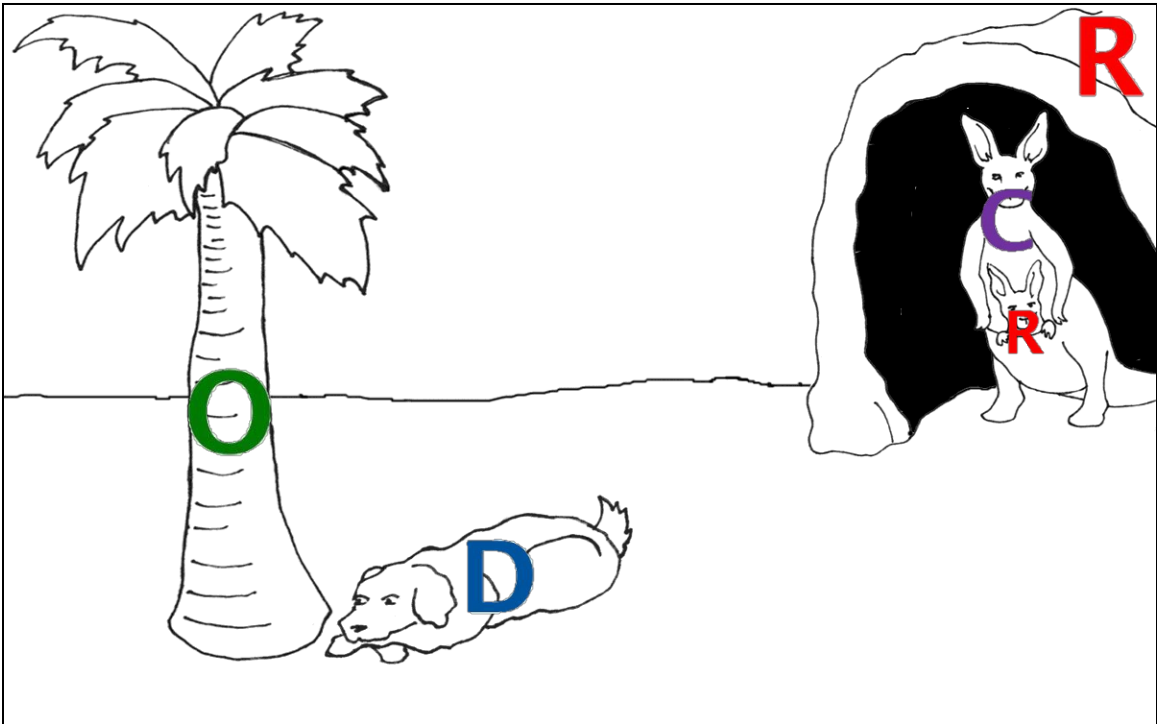
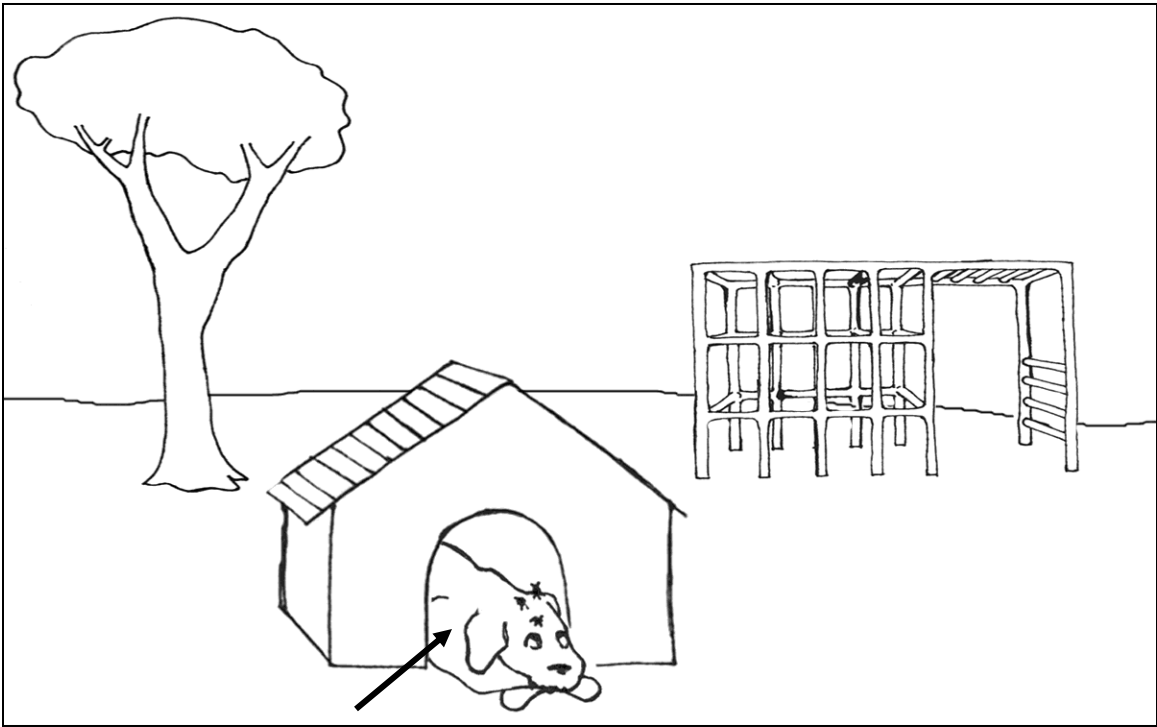

Problem 15-  
2a

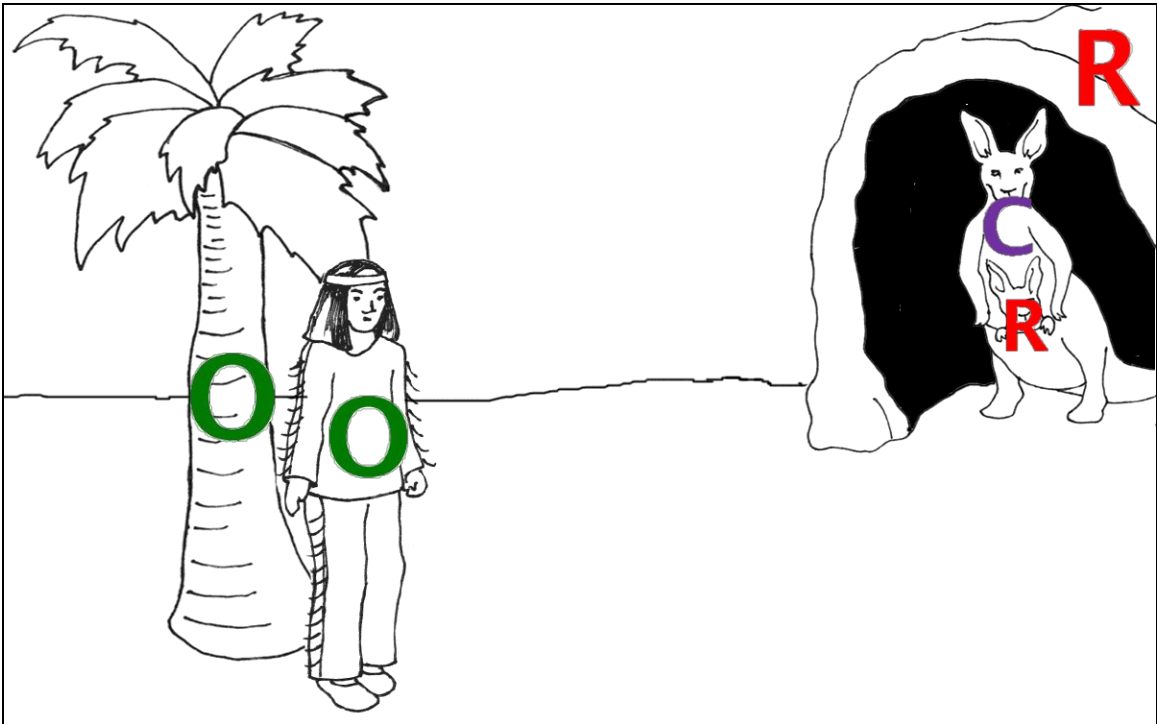
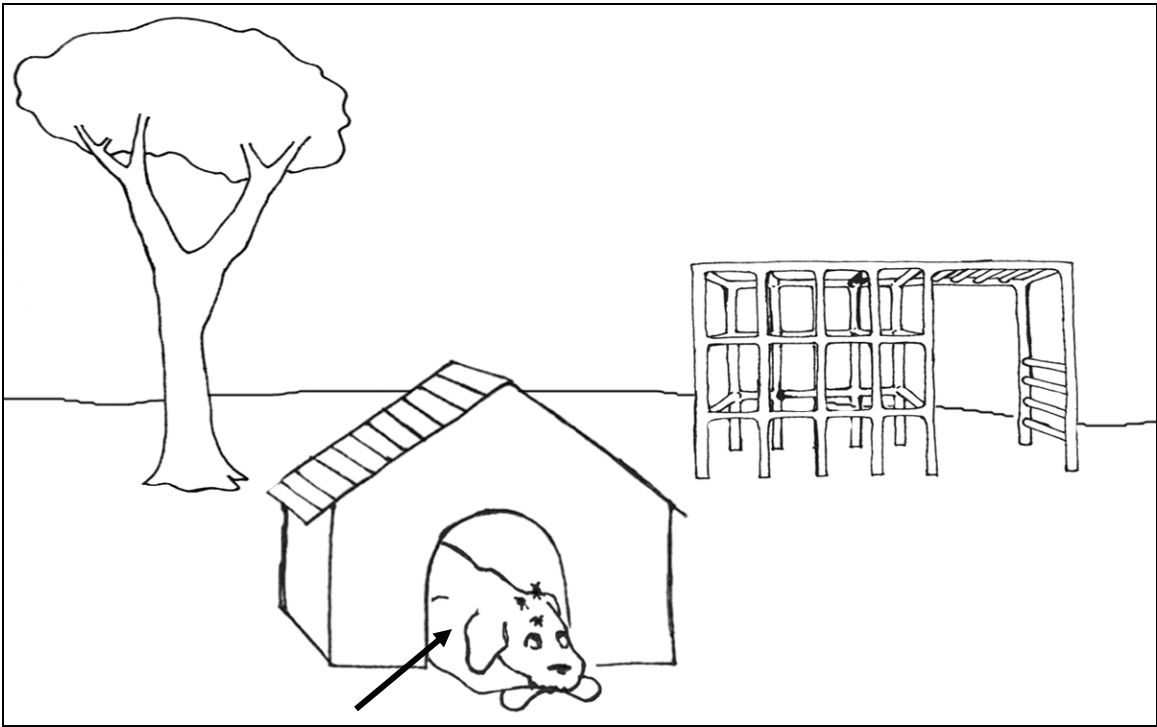

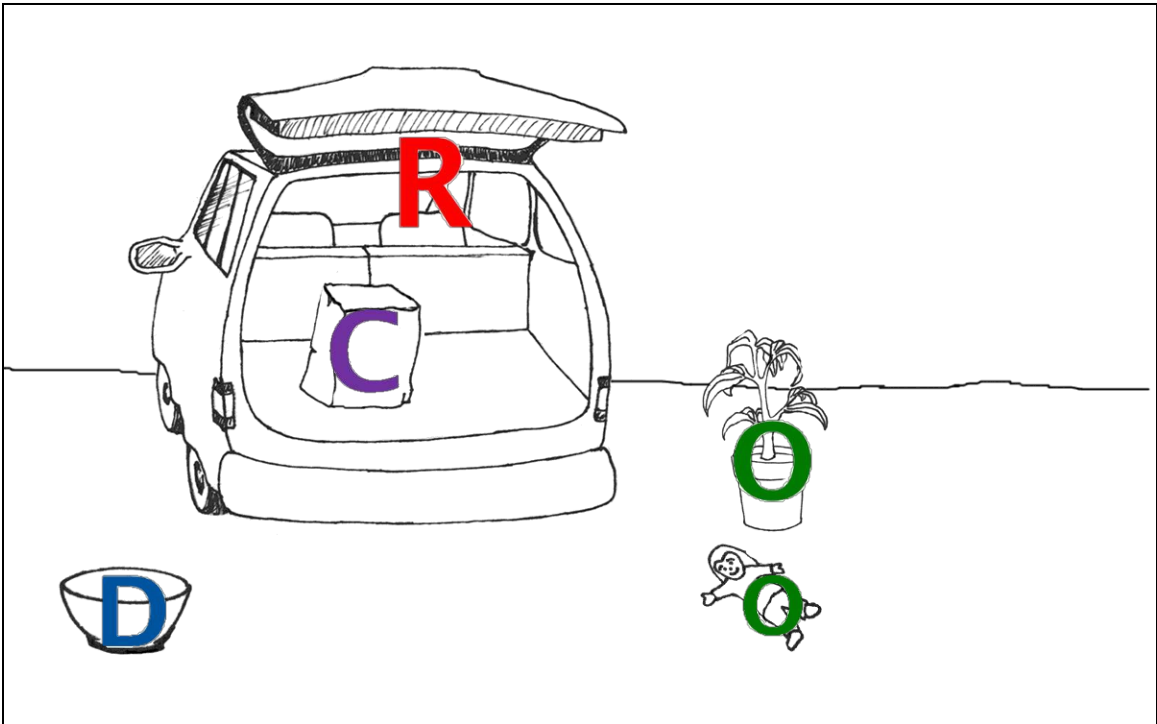
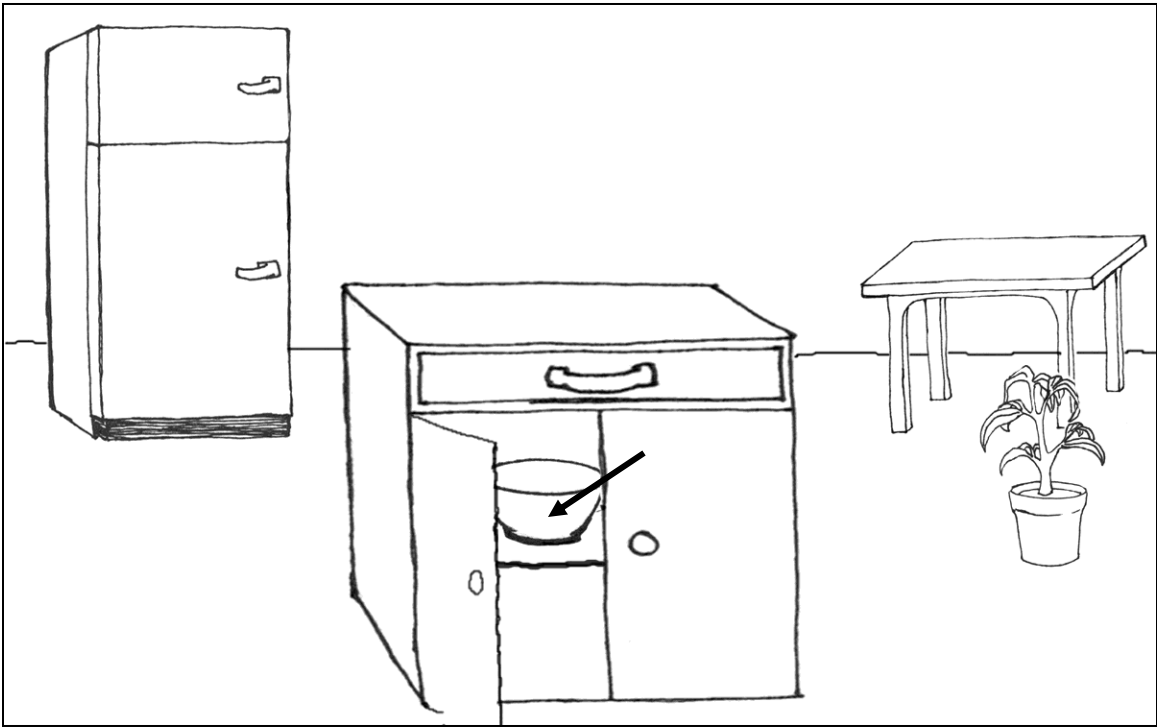

Problem 16-  
1a

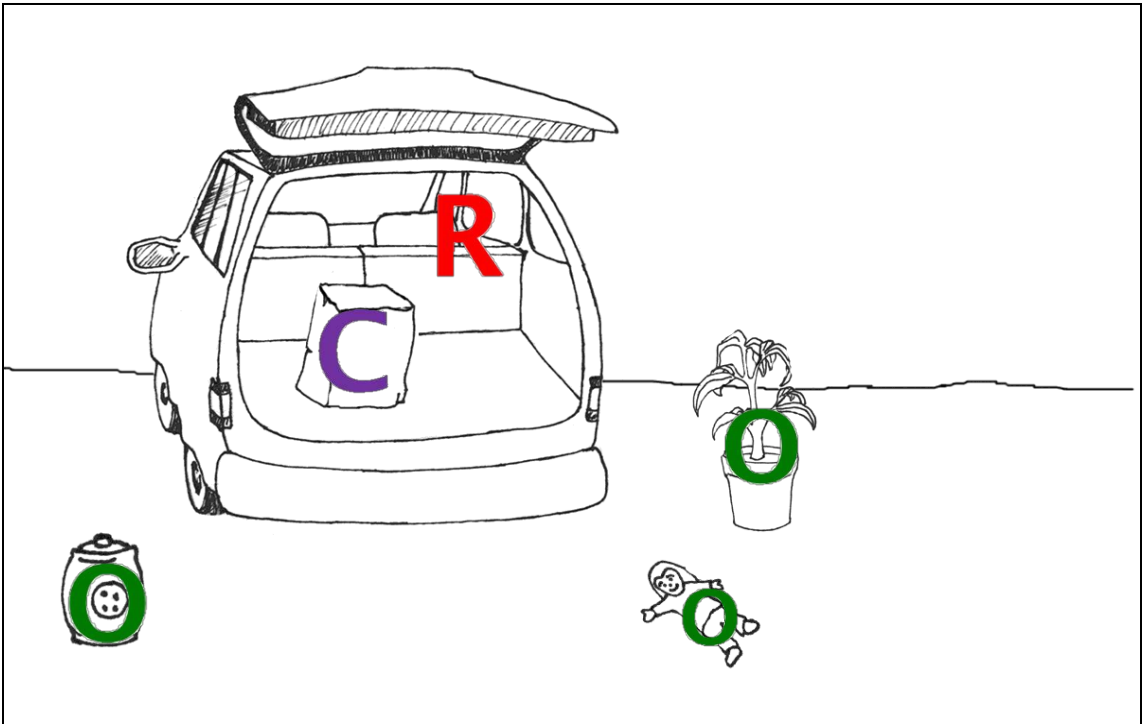
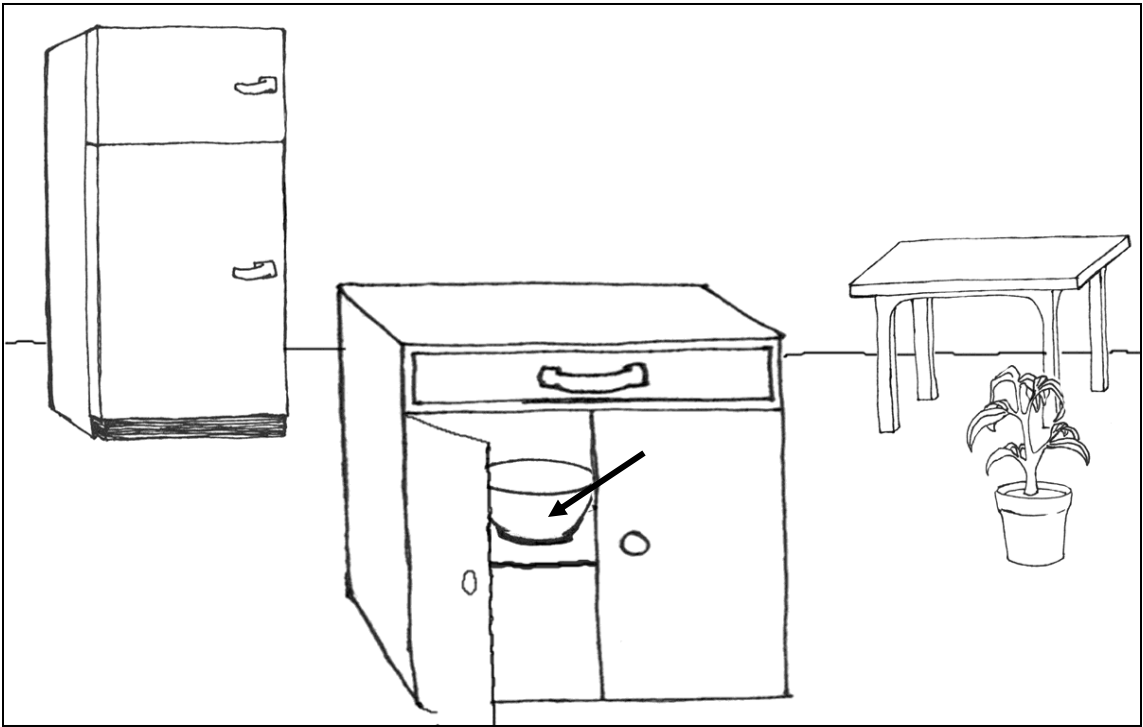

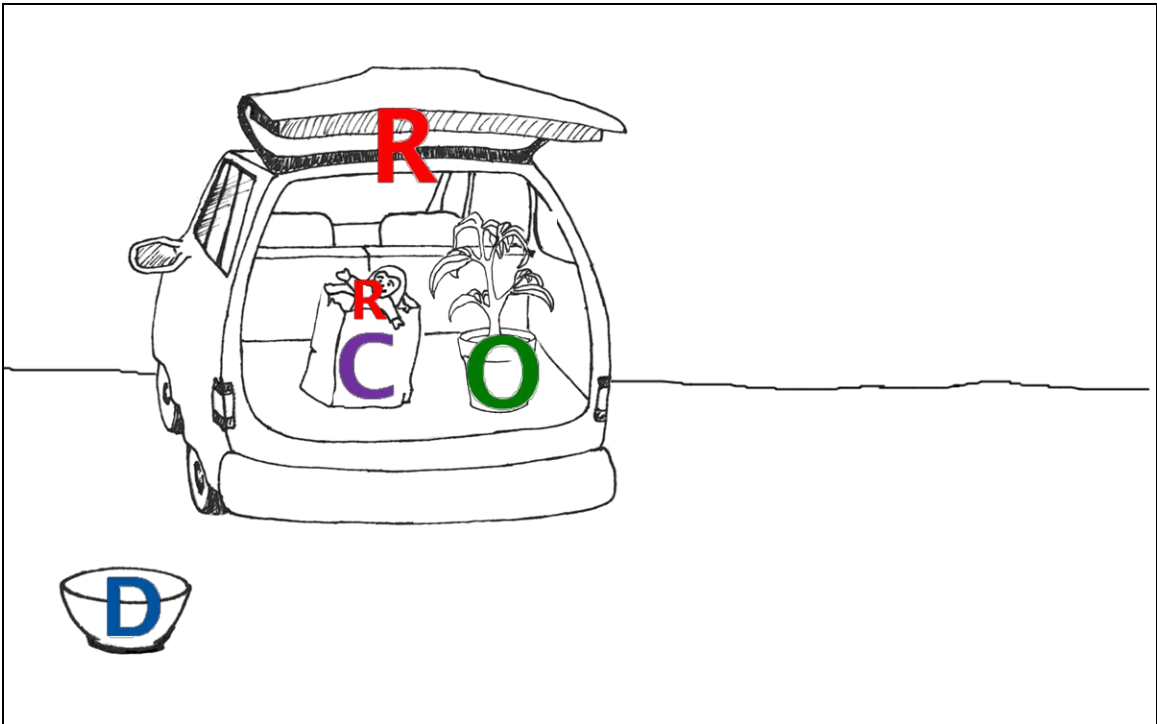
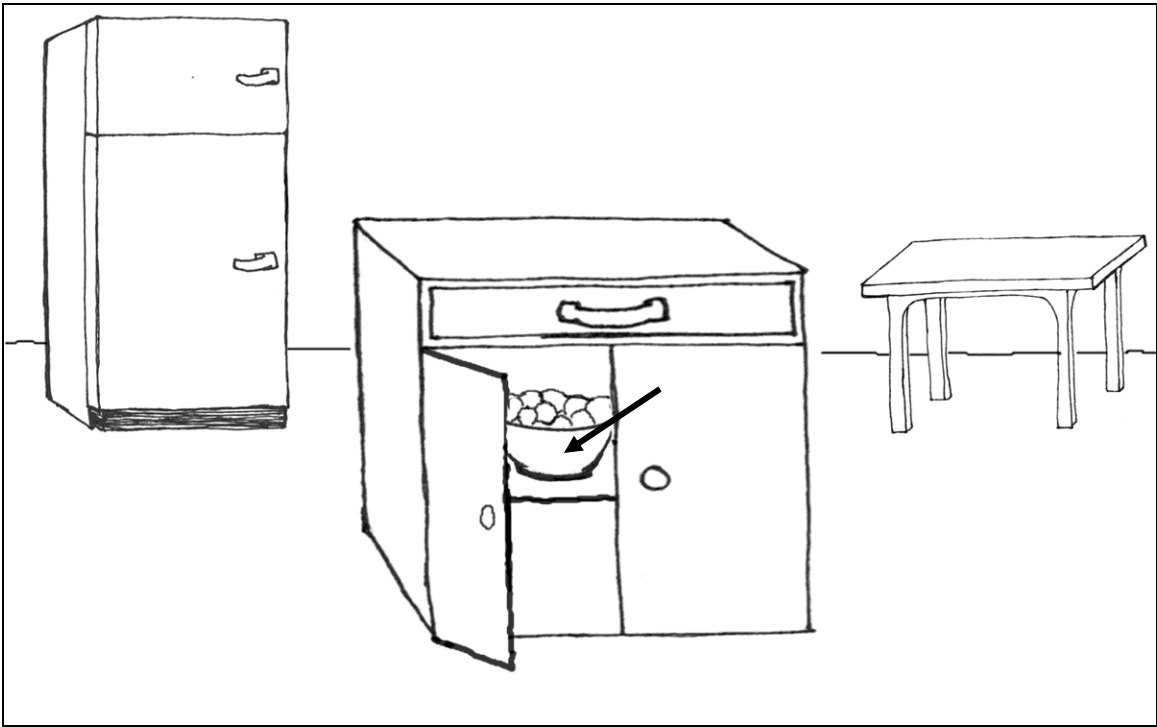

Problem 16-  
2a

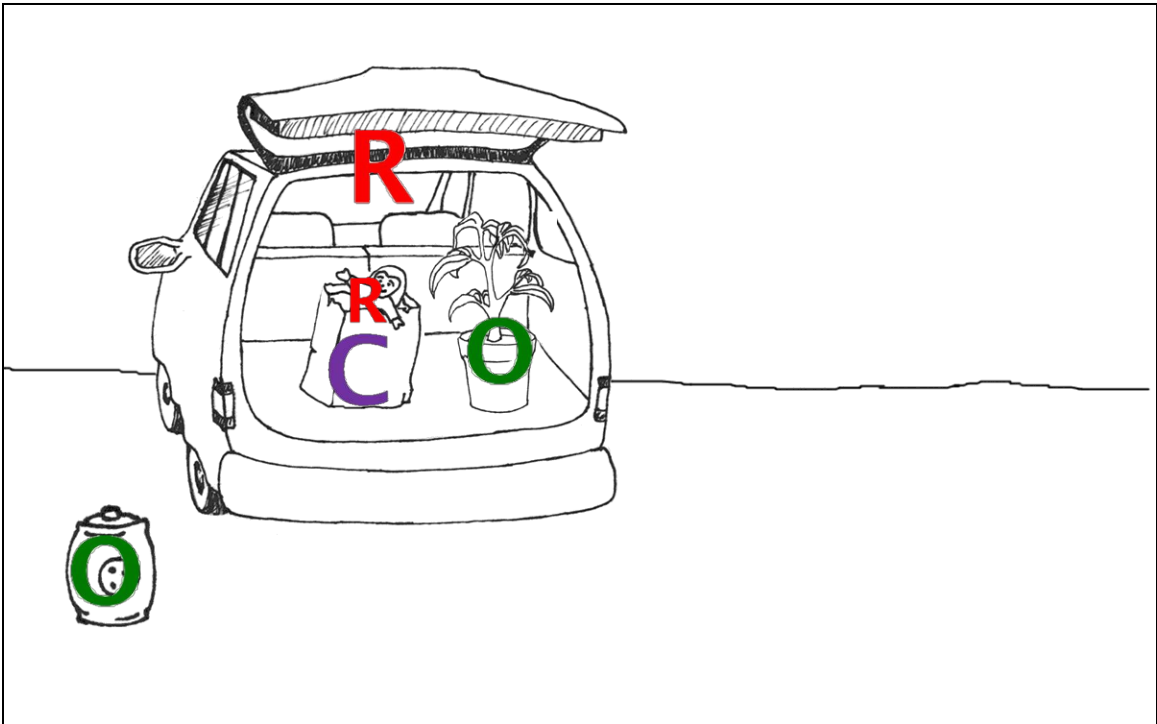
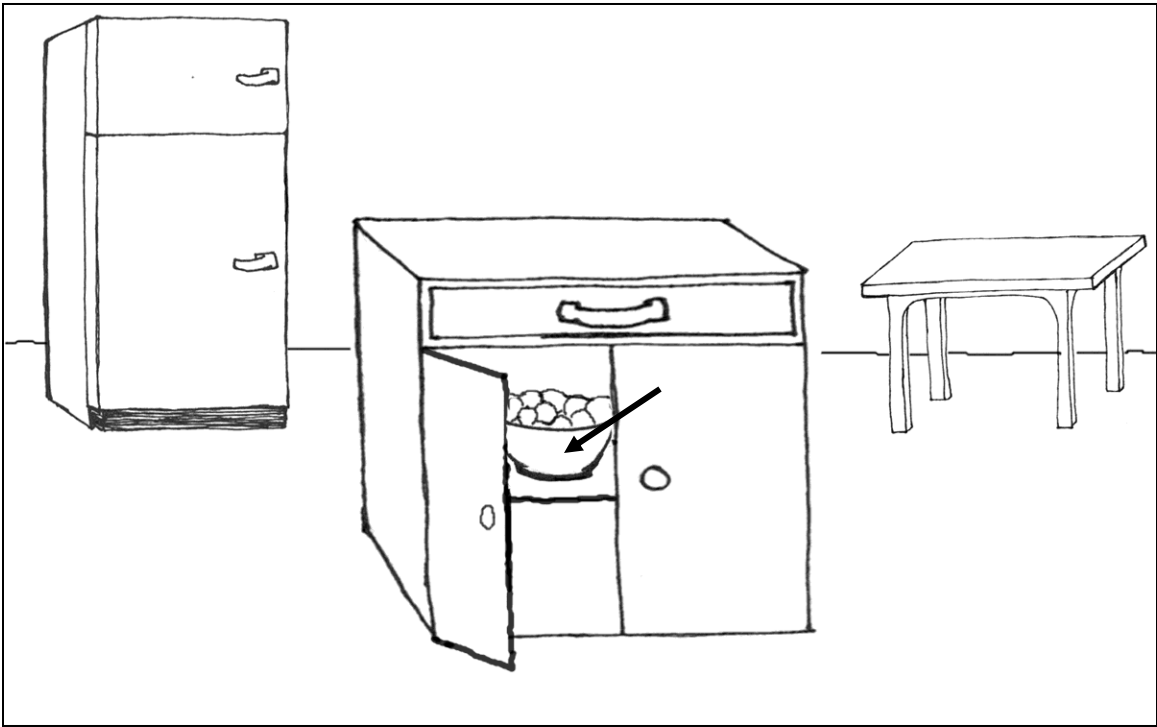

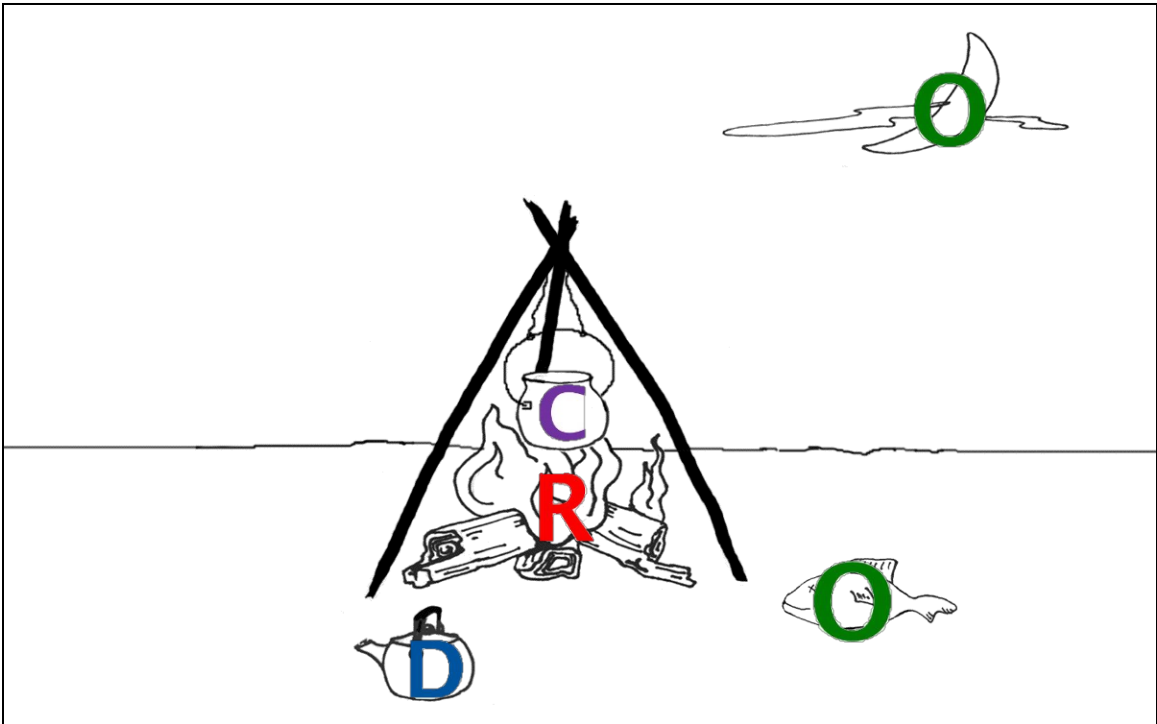
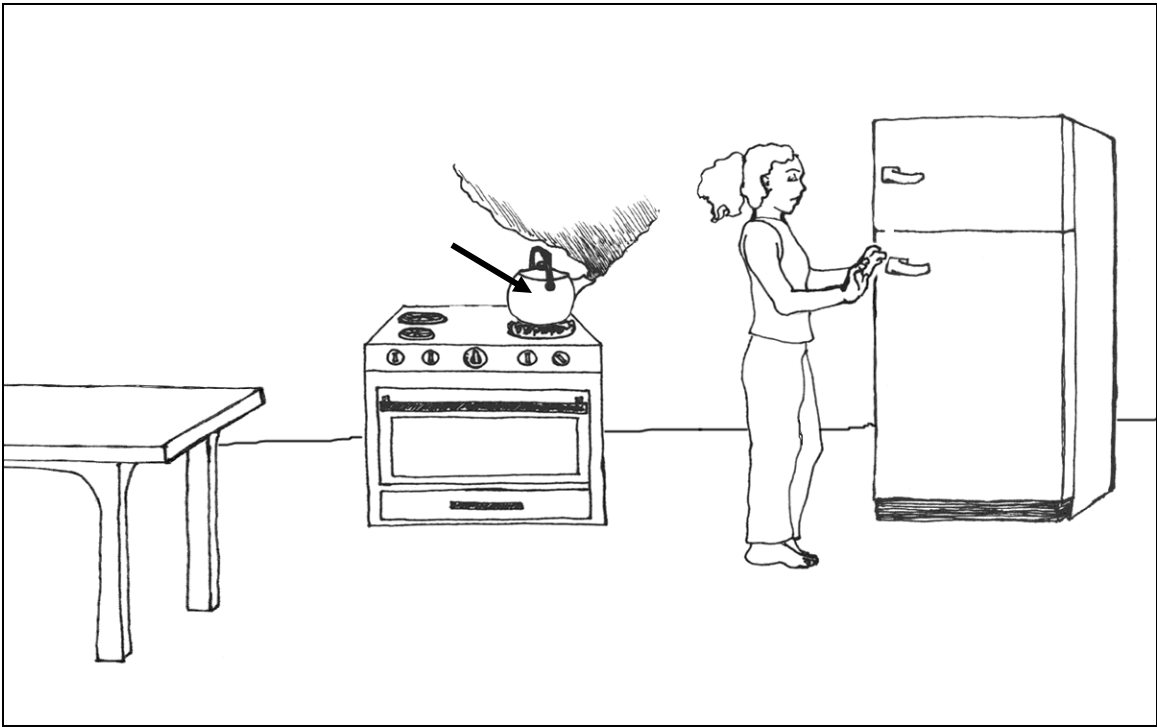

Problem 17-  
1a



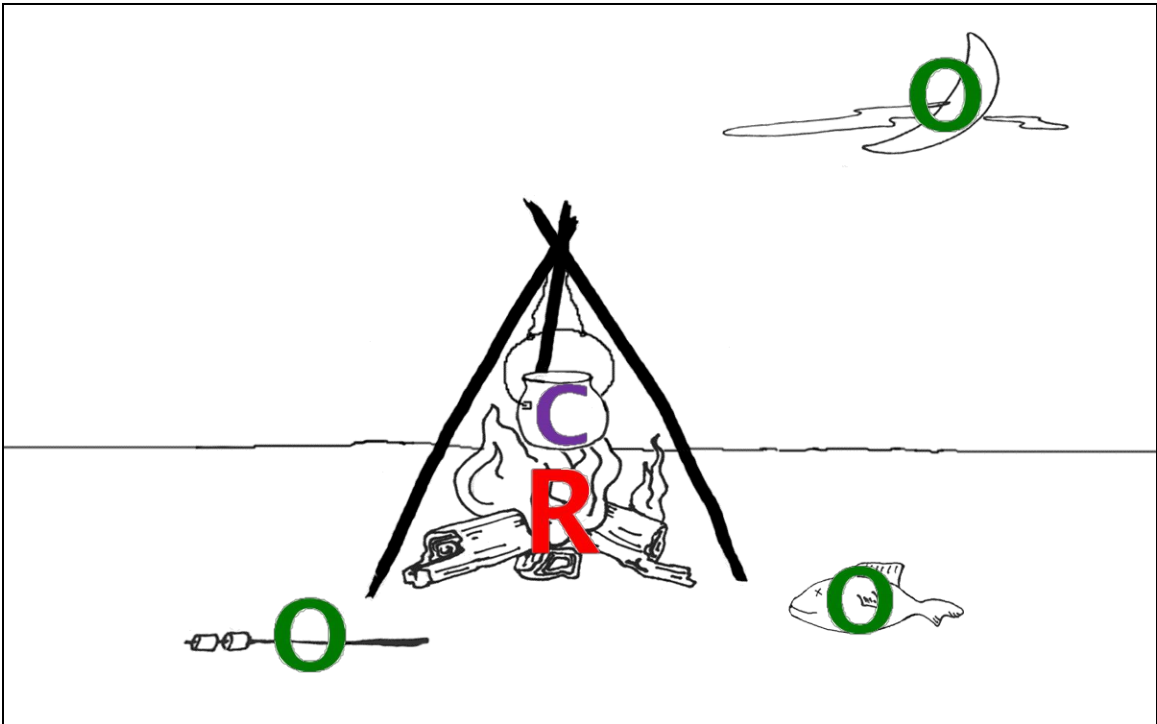
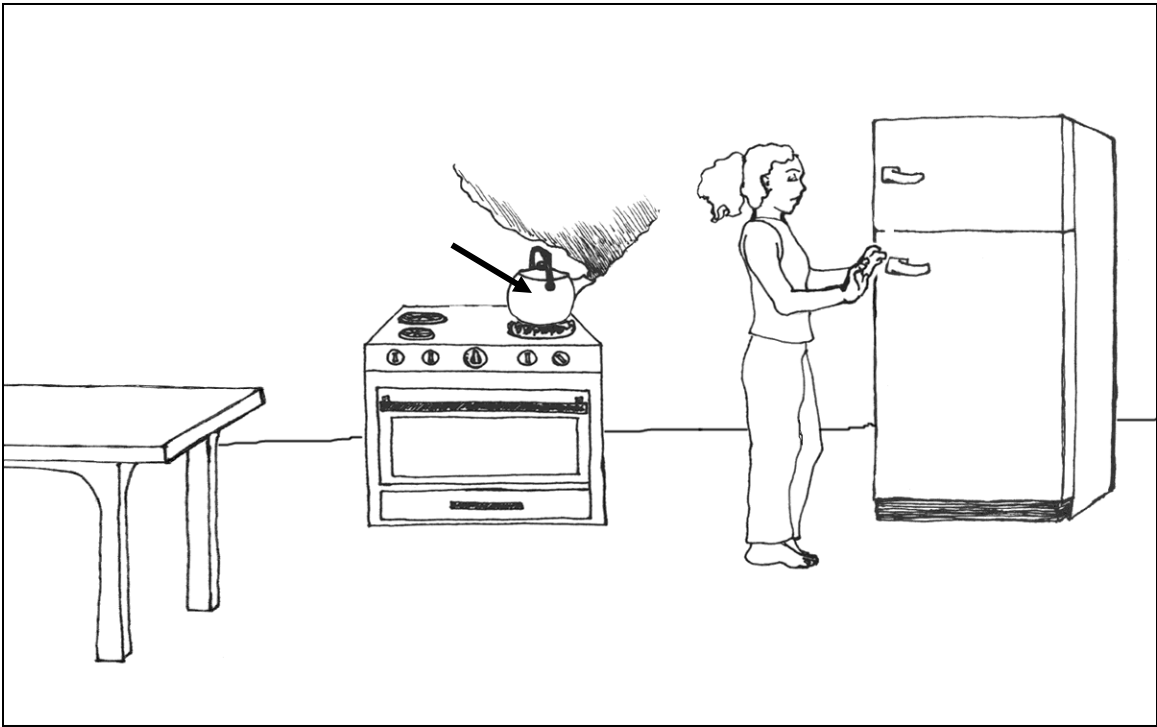

Problem 17-1b

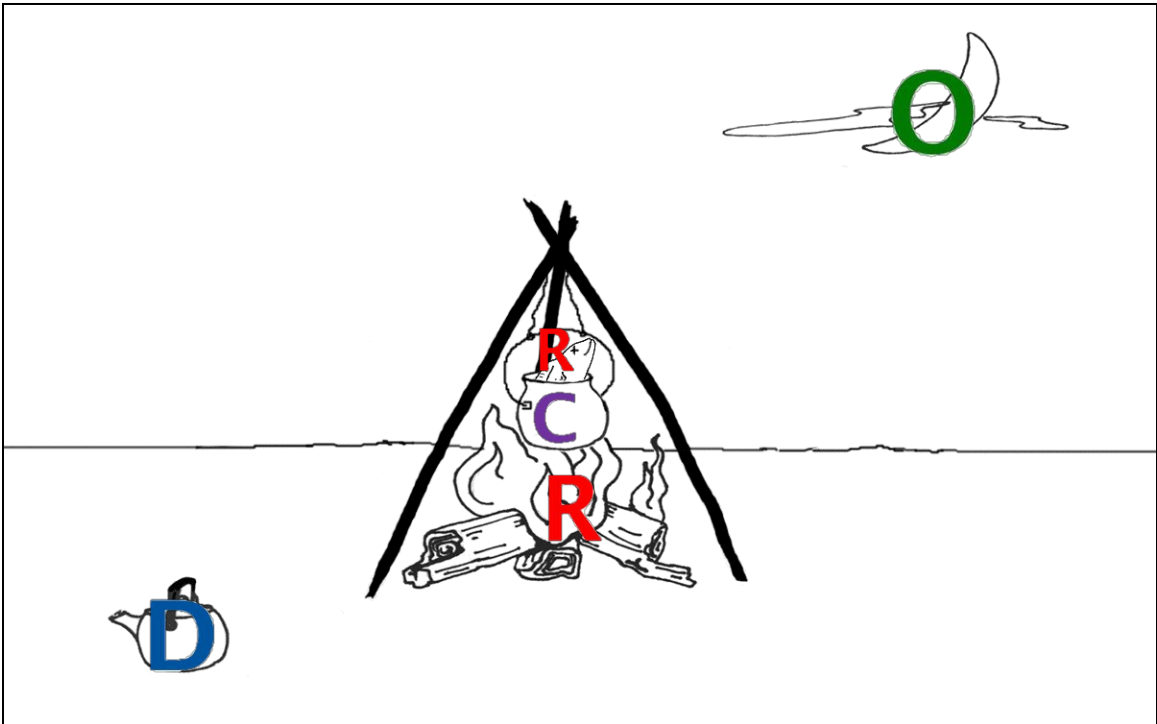
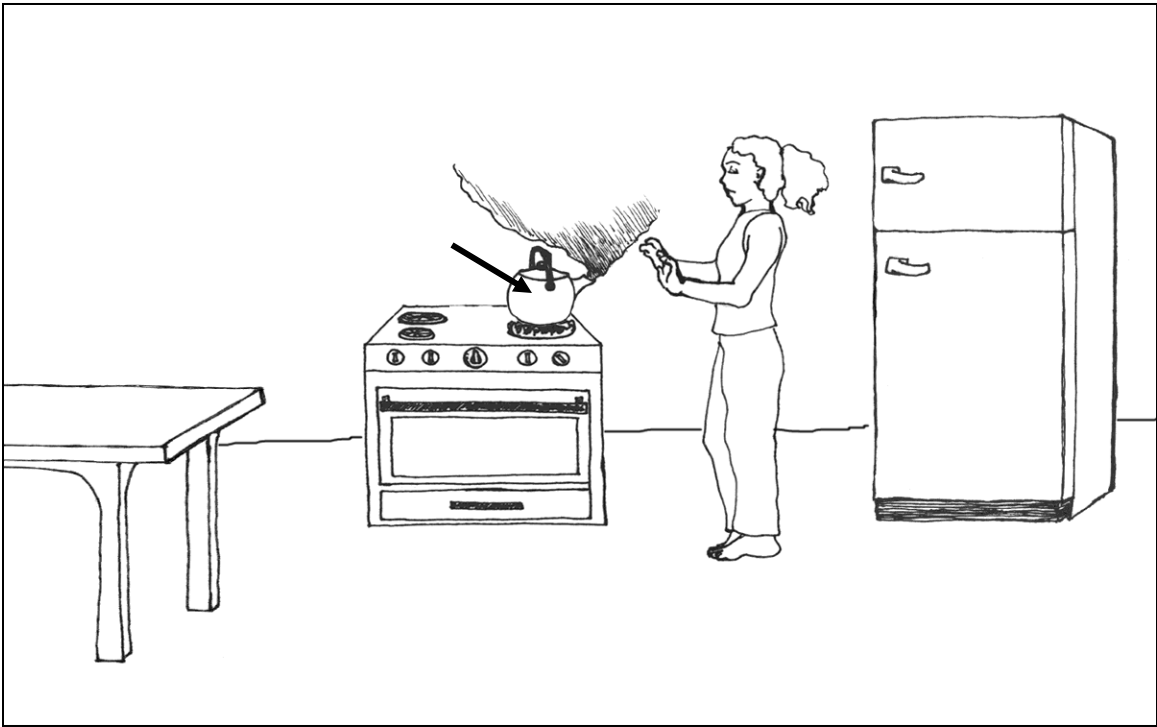

Problem 17-  
2a

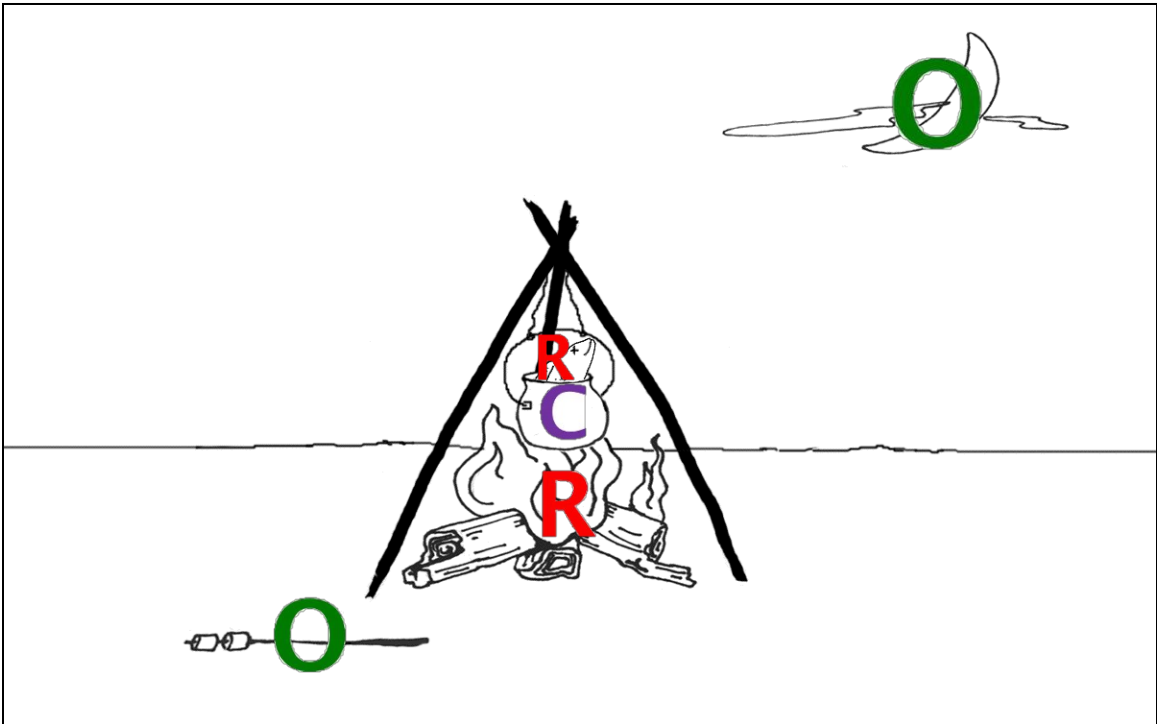
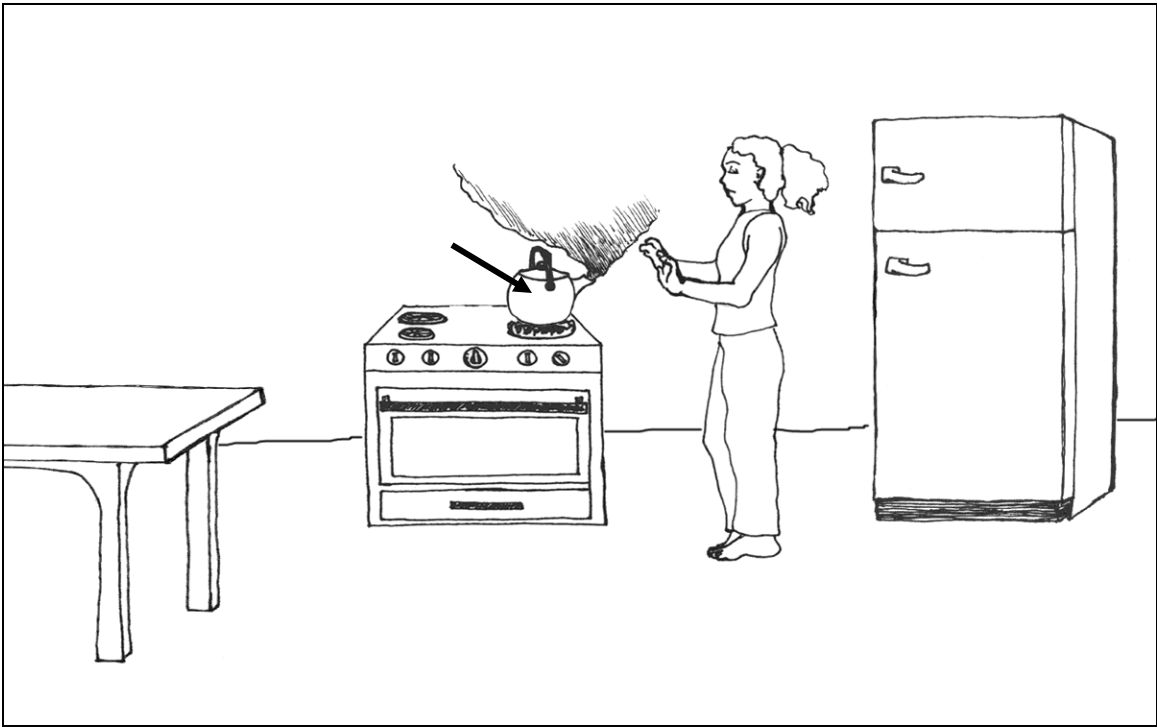

Problem 17-  
2b

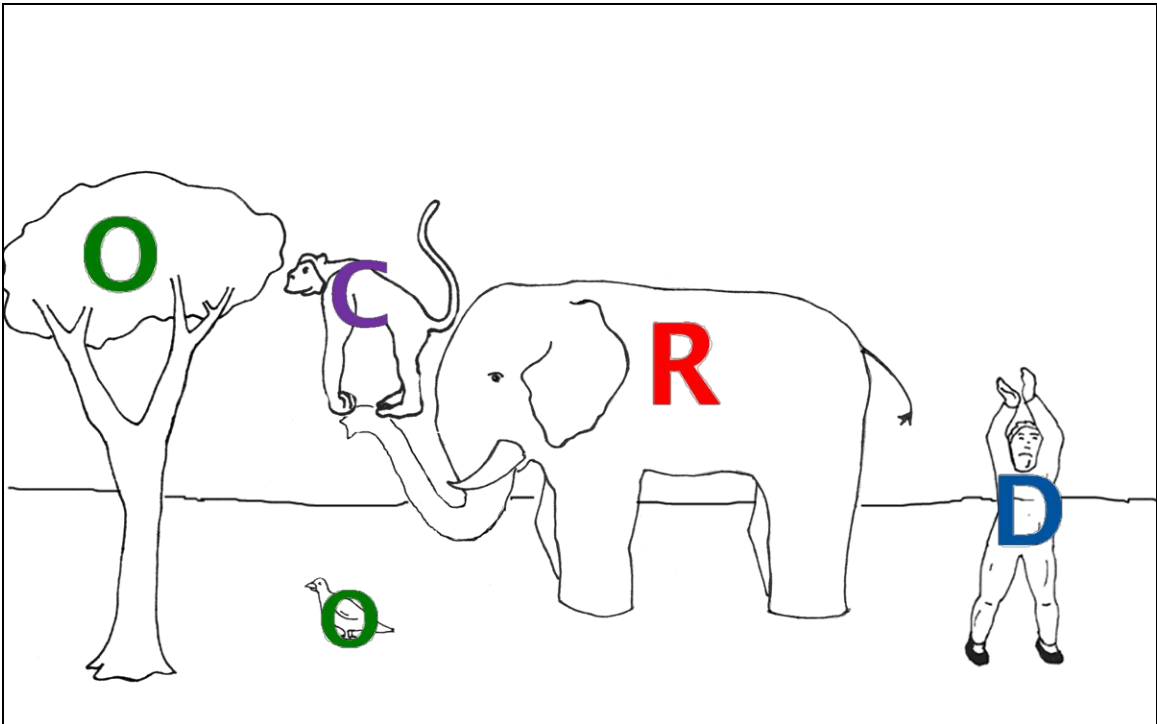
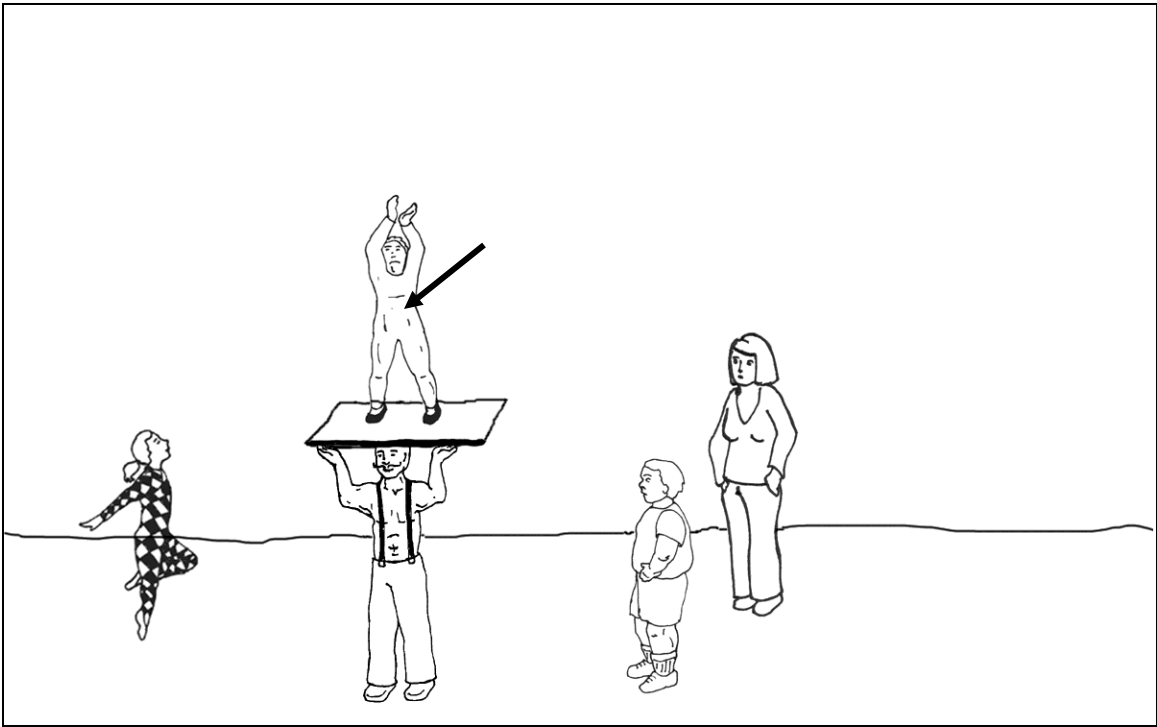

Problem 18-  
1a

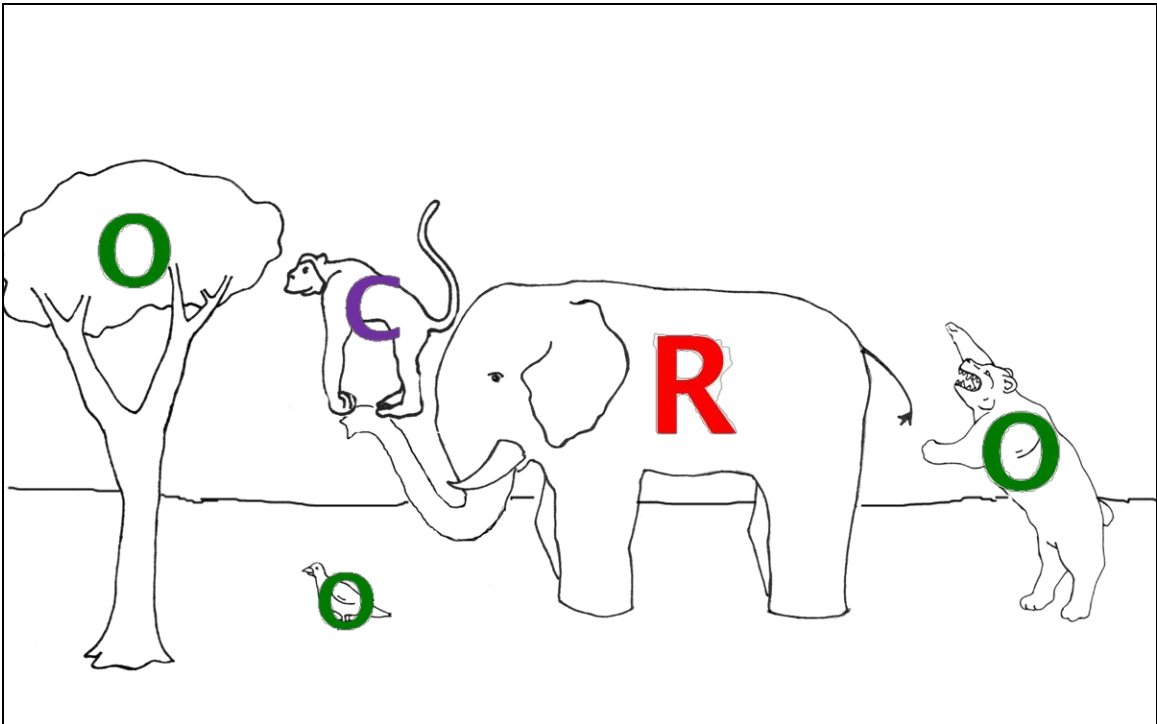
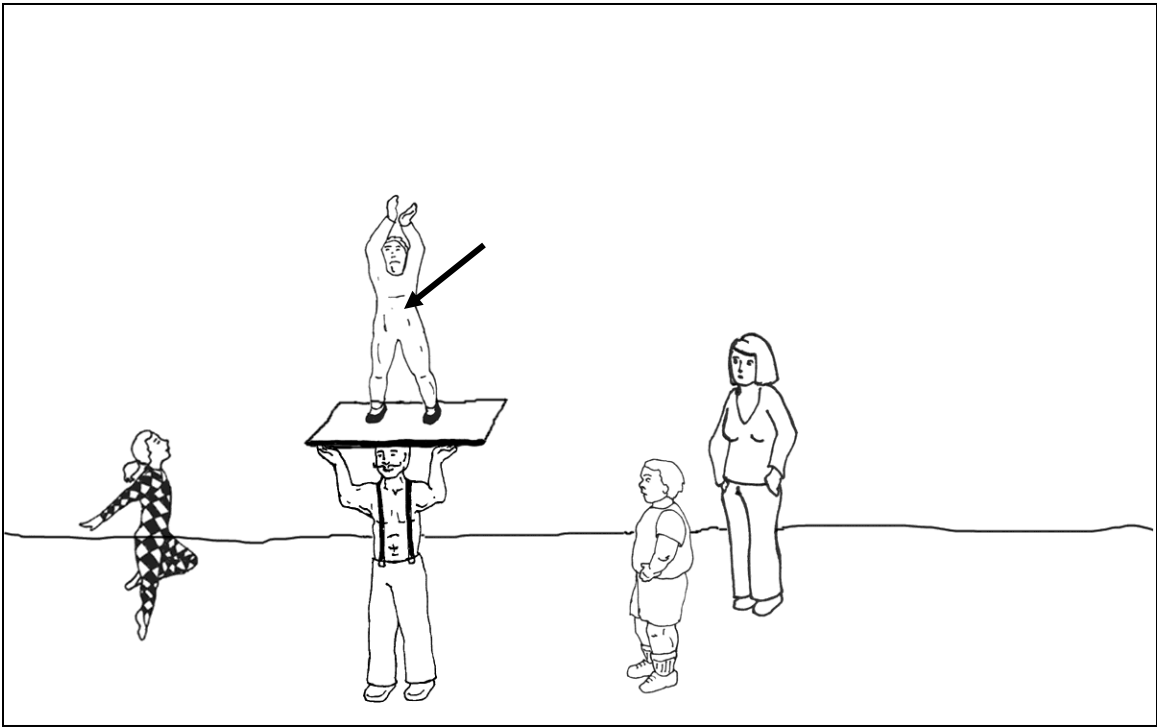

Problem 18-  
1b

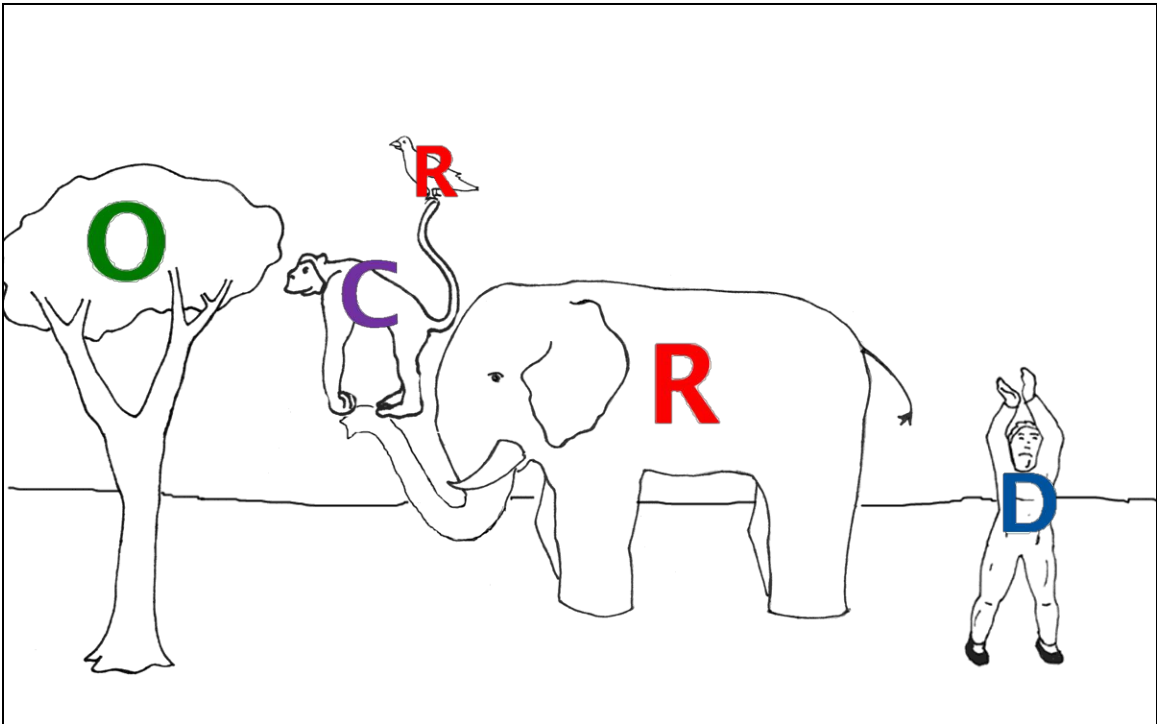
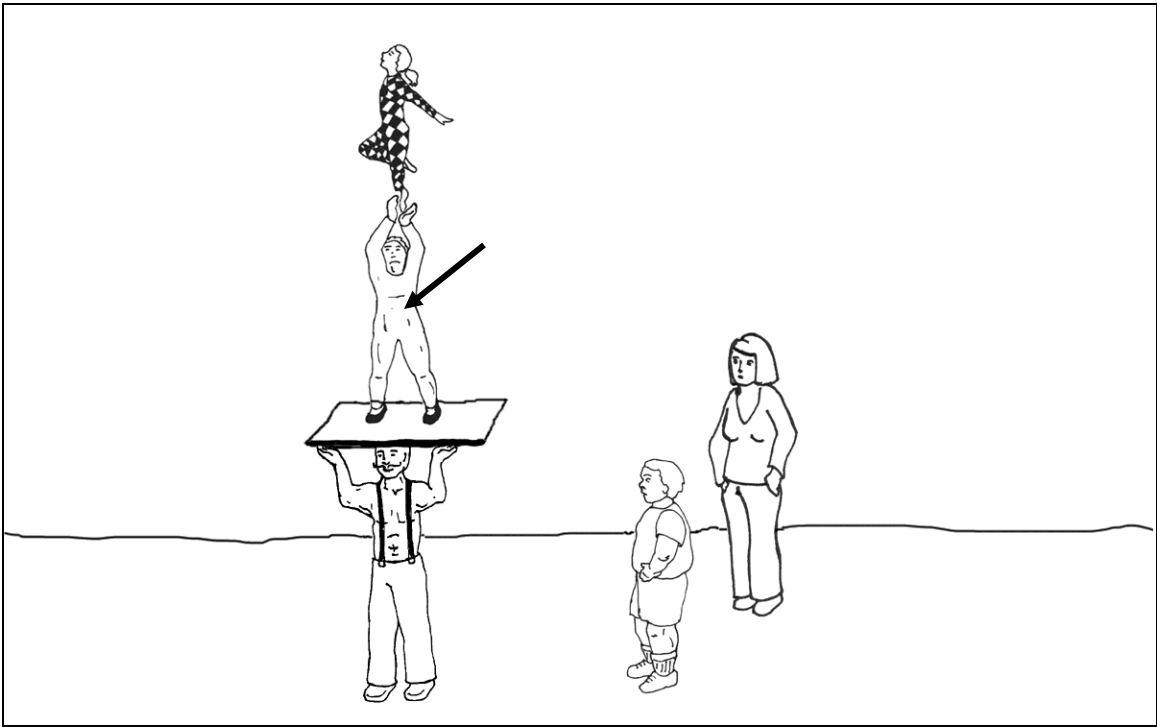

Problem 18-  
2a

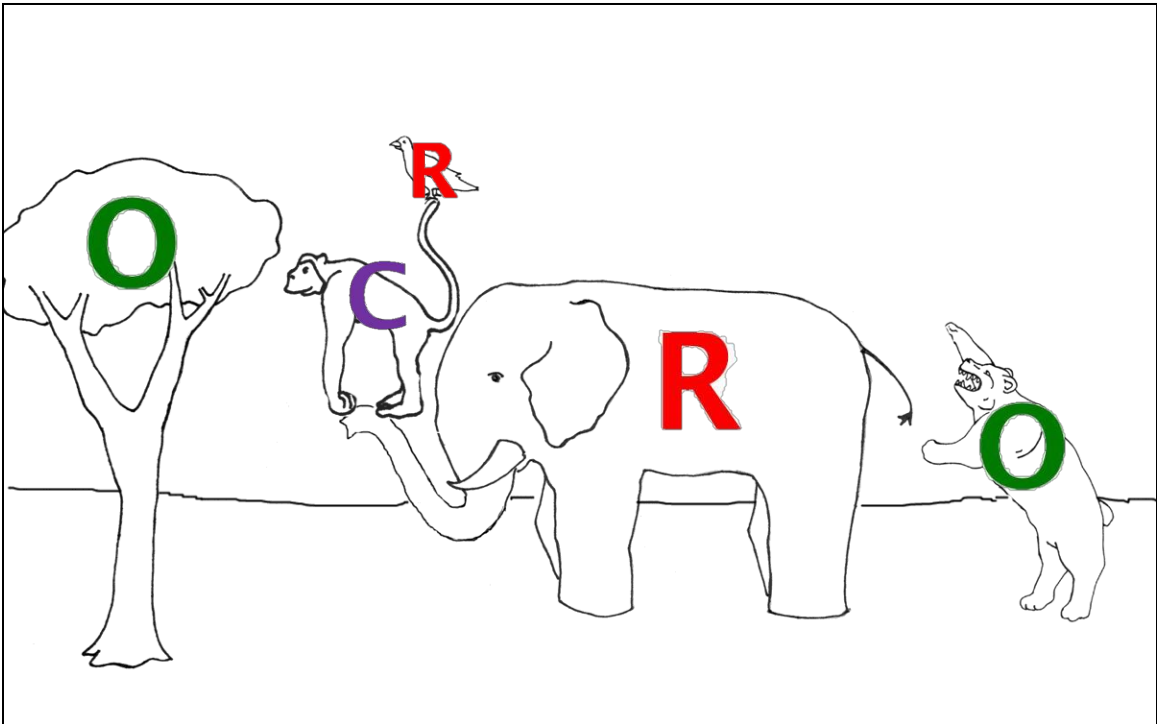
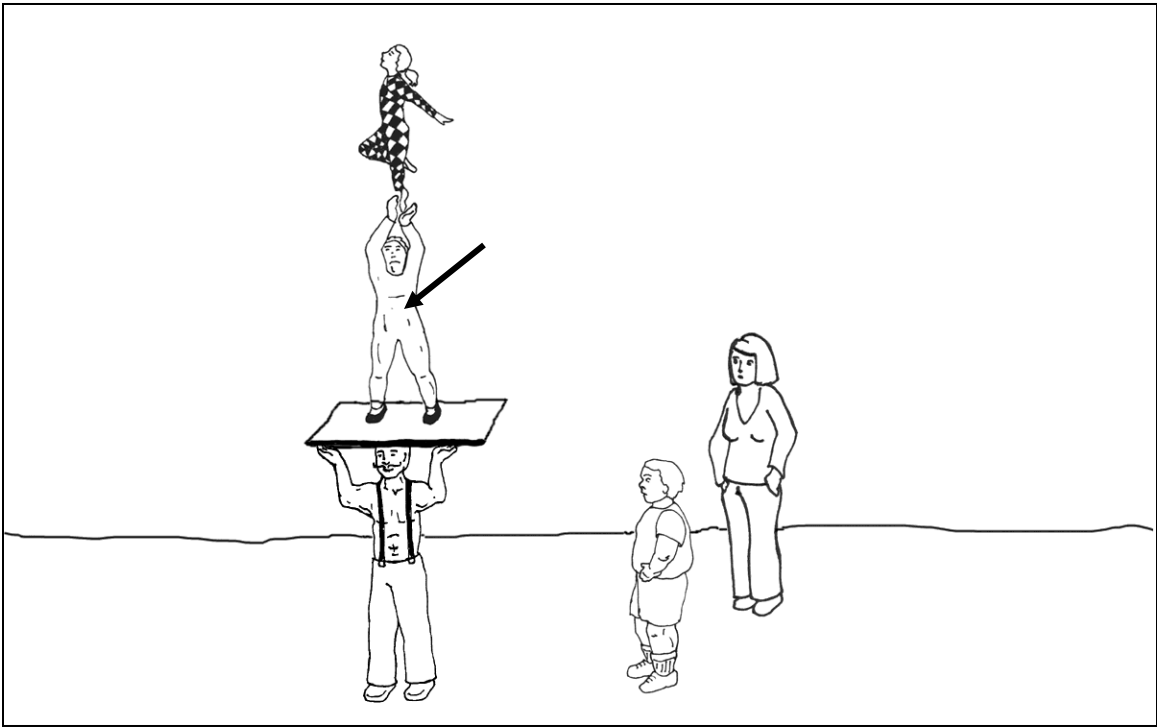

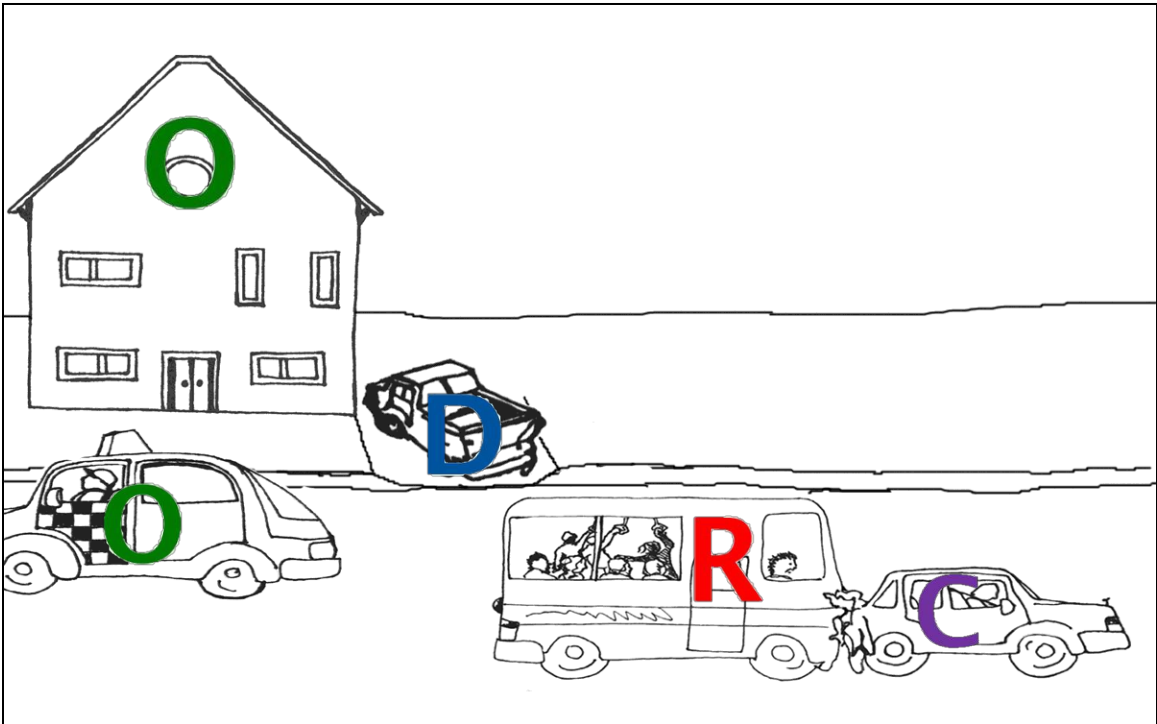
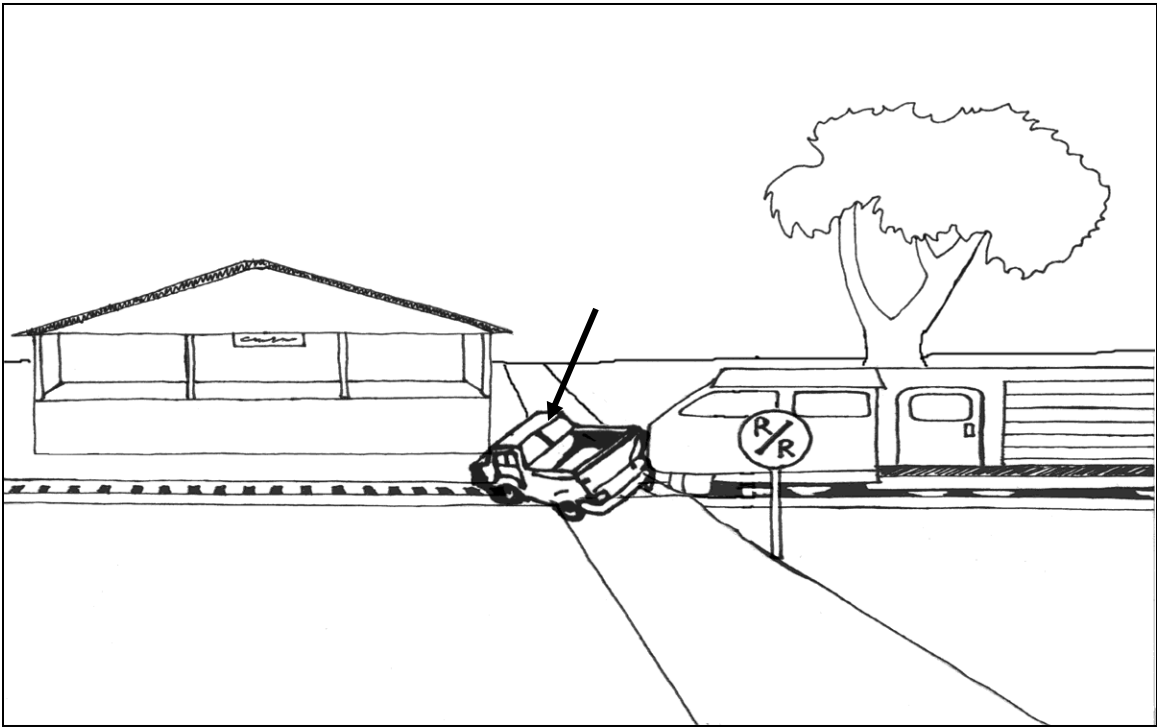

Problem 19-  
1a



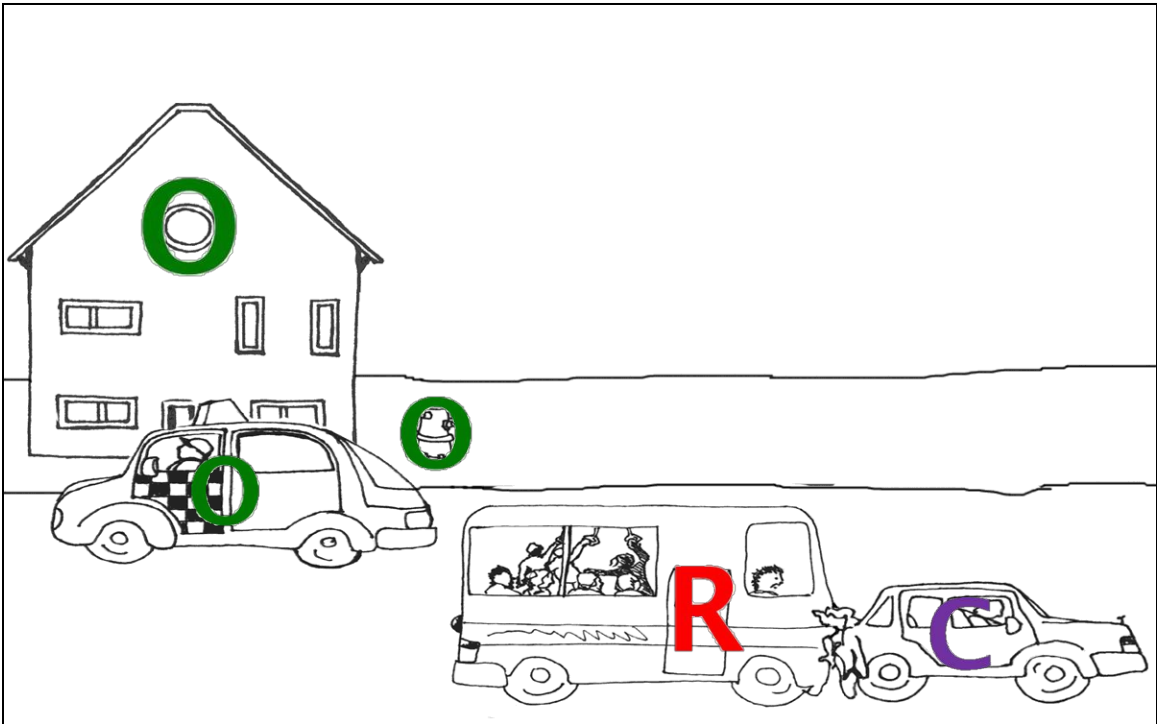
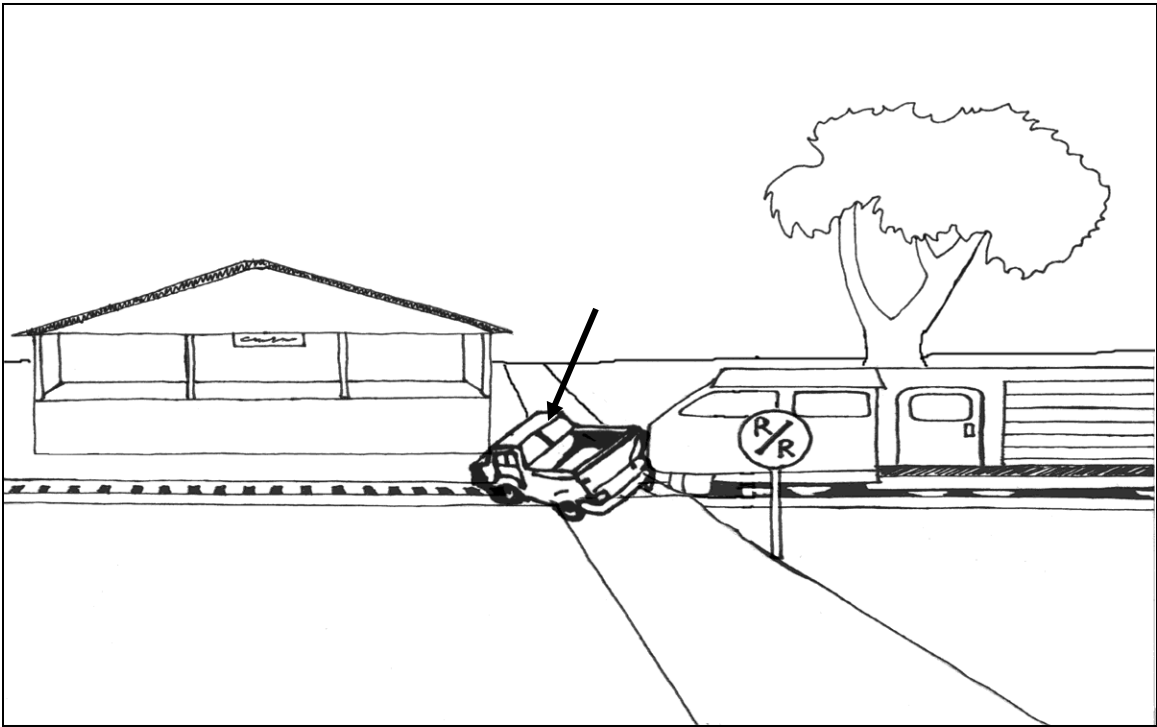

Problem 19-  
1b

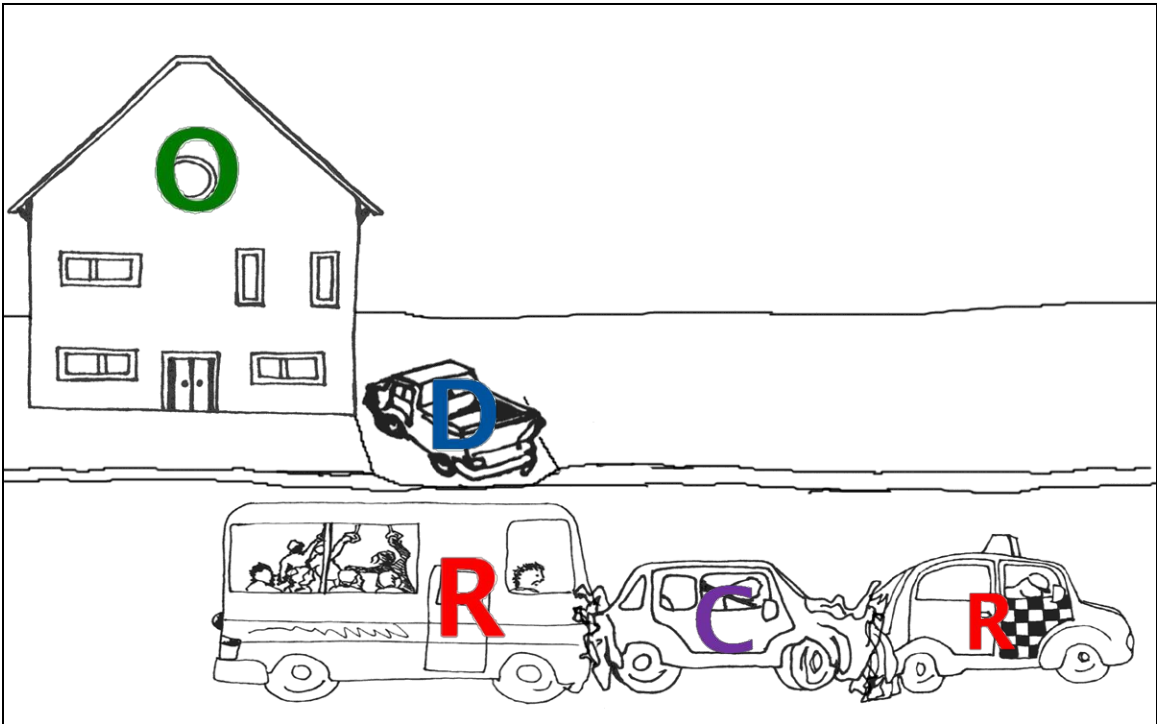
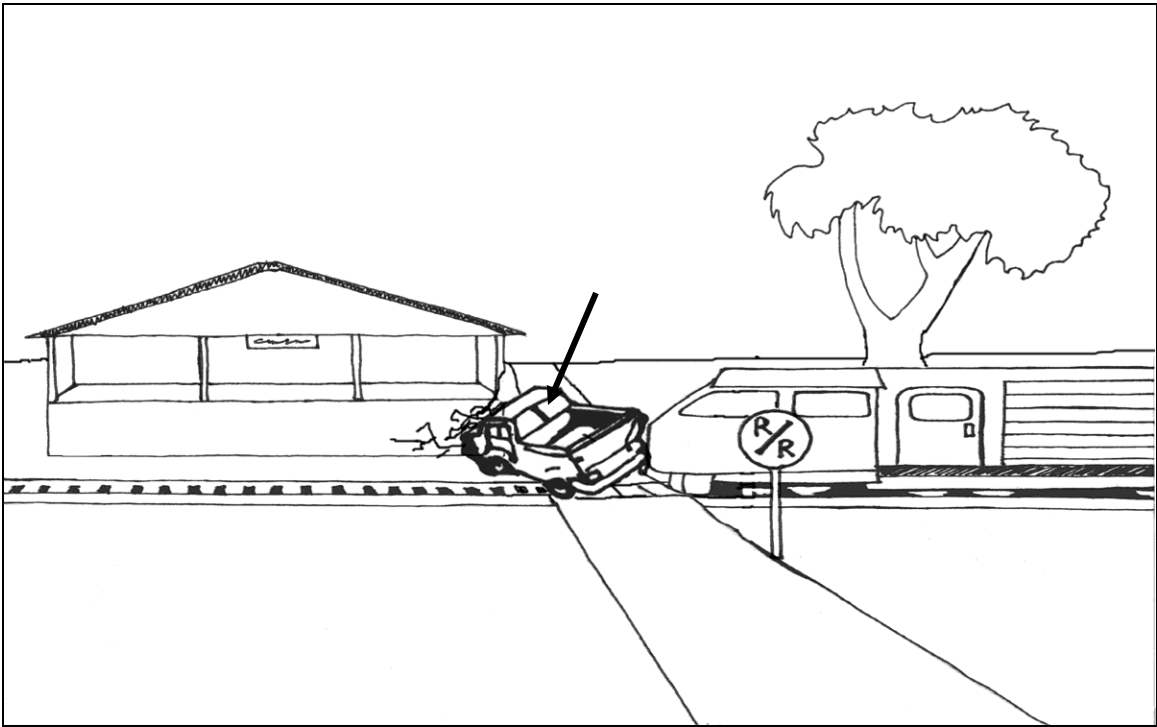

Problem 19-  
2a

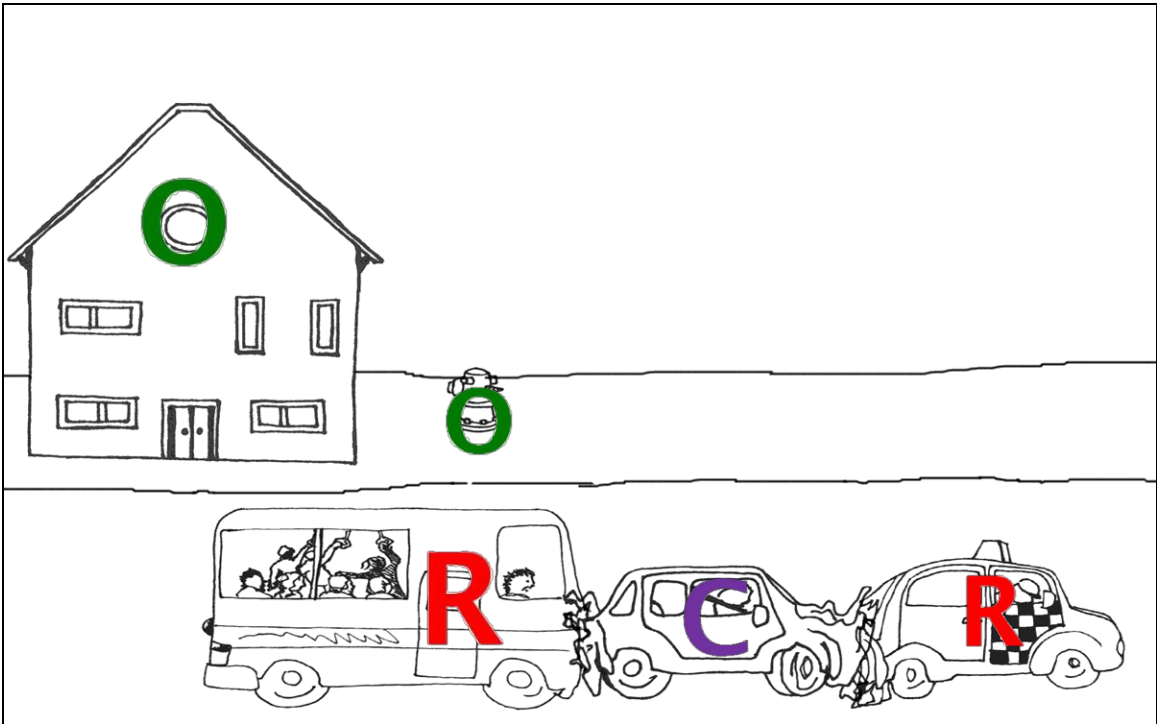
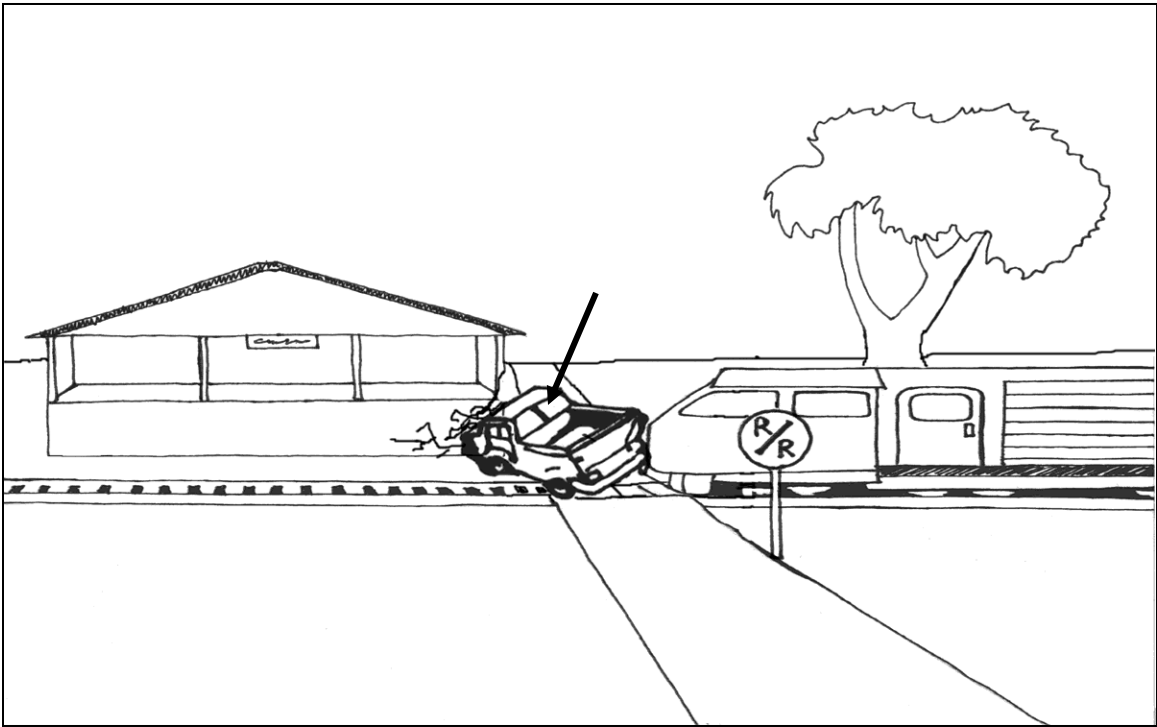

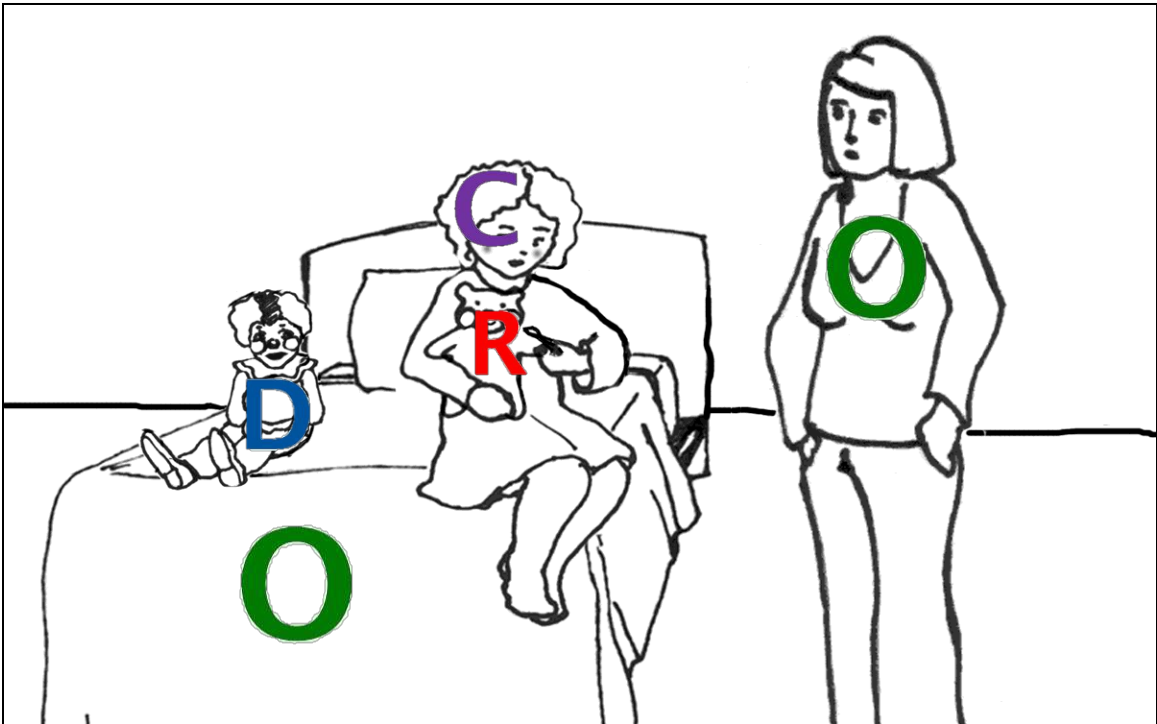
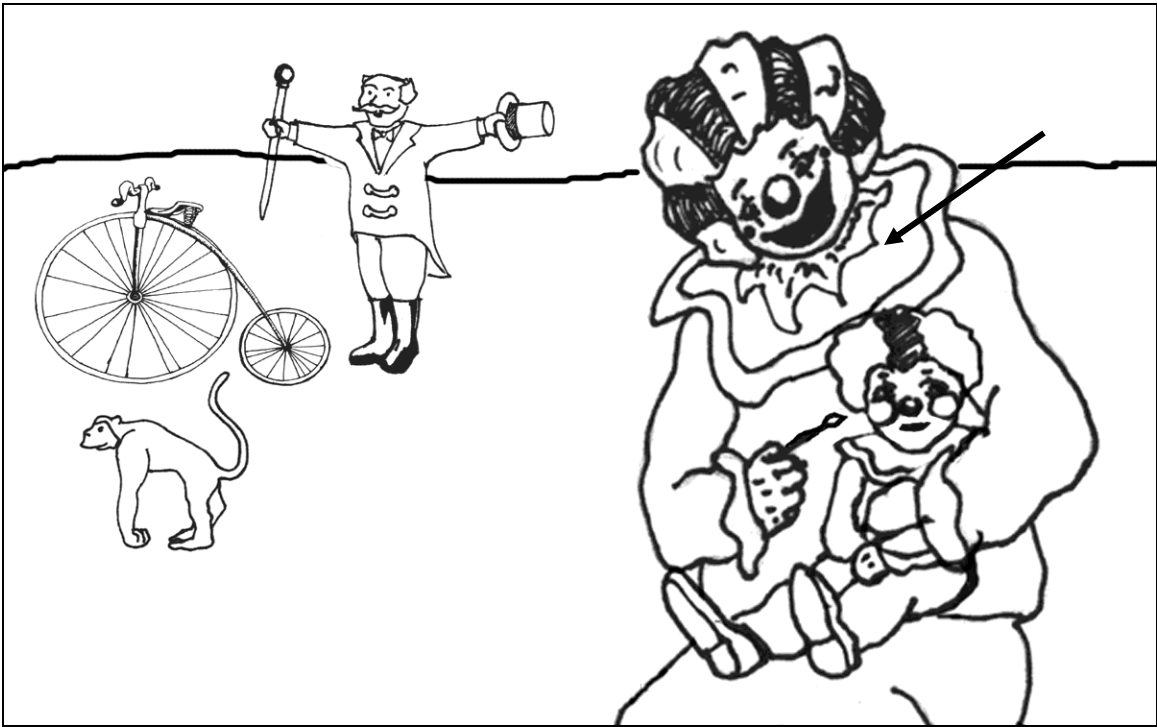

Problem 20-1a

